

PROJECT GUIDE

HIMSEN H17/28E(U)

FOR MARINE

2022 2nd EDITION



DISCLAIMER

All information provided in this document is for informational purposes only.

It is not a definitive binding document and may be changed without prior notice. In addition, there are no guarantees or warranties for any particular content. Depending on the requirements of the specific project in the future, related data and documents may be changed, and specifications should be determined after evaluation by specific project. This should be determined according to each individual project, that is, the specifications required for the specific area and specific operating conditions.

	Page	
1	General information	
1.1	Introduction	7
1.2	Engine nomenclature	8
2	Structural design and installation	
2.1	Principal data	9
2.2	Engine cross section	10
2.3	Engine design outline	11
2.4	Generating-set dimension and weight	13
2.5	Mounting	14
2.6	Overhaul dimension	16
3	Performance data	
3.1	Rated power for Generating-set	17
3.2	Engine capacity data	18
3.3	Engine performance	22
3.4	Exhaust gas emission	30
3.5	Power de-rating diagram	32
3.6	Correction of fuel oil consumption	33
3.7	Correction of exhaust gas temperature	35
4	Dynamic characteristics and noise	
4.1	External forces and couples	37
4.2	Moment of inertia	38
4.3	Noise measurement	39

	Page	
5	Operation and control system	
5.1	Engine operation	41
5.2	Outline of engine automation	46
5.3	Operation data and alarm points	48
5.4	HiEMS	51
6	Fuel system	
6.1	Internal fuel oil system	55
6.2	External fuel oil system	57
6.3	Fuel oil specification	64
6.4	Fuel oil viscosity diagram	75
6.5	Fuel oil quality	76
7	Lubricating oil system	
7.1	Internal lubricating oil system	79
7.2	External lubricating oil system	82
7.3	Lubricating oil specification	86
7.4	List of lubricants	88
8	Cooling water system	
8.1	Internal cooling water system	91
8.2	External cooling water system	94
8.3	Cooling water quality and treatment	99

	Page	
9	Air and exhaust gas system	
9.1	Internal compressed air system	101
9.2	External compressed air system	103
9.3	Internal combustion air system	105
9.4	External combustion air system	106
9.5	External exhaust gas system	108
9.6	External exhaust gas pipe connection	110
9.7	Approach of SCR system installation	111
9.8	Exhaust gas silencer with spark arrestor	113
9.9	Exhaust gas silencer without spark arrestor	115
9.10	Generator information	117
10	Engine maintenance	
10.1	Maintenance schedule	119
10.2	Recommended wearing parts	127
10.3	List of standard spare parts	131
10.4	Heavy parts for maintenance	133
10.5	List of standard tools	135
11	Appendix 1 (Piping symbols)	139
12	Appendix 2 (Instrumentation code)	143
13	Note	145

This page is intentionally blanked

1 General information

1.1 Introduction

This project guide provides necessary information and recommendations for the application of HYUNDAI HiMSEN H17/28E(U) generating-set (gen-set). 'HiMSEN'® is the licensed brand name of HYUNDAI's own design engine and the abbreviation of 'Hi-Touch Marine & Stationary ENgine'. The HiMSEN H17/28E(U) generating sets are delivered as complete packages, an engine and a generator are mounted on a common base frame together with related auxiliary equipment.

Please note that all data and information prepared in this project guide are for guidance only and subject to revision without notice. Therefore, please contact Hyundai Heavy Industries Co., Ltd. before actual applications of the data. Hyundai Heavy Industries Co., Ltd. (HHI) will always provide the data for the installation of specific project.

Each sheet is identified by the engine type and own 'Sheet Number'. Therefore, please use engine type 'H17/28E(U)', and 'Sheet No.' for easier communications.

Engine model designation

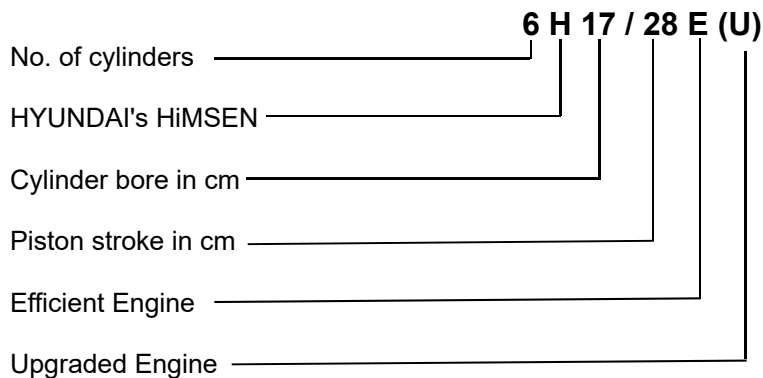

1.2 Engine nomenclature

1.2.1 Cylinder numbering

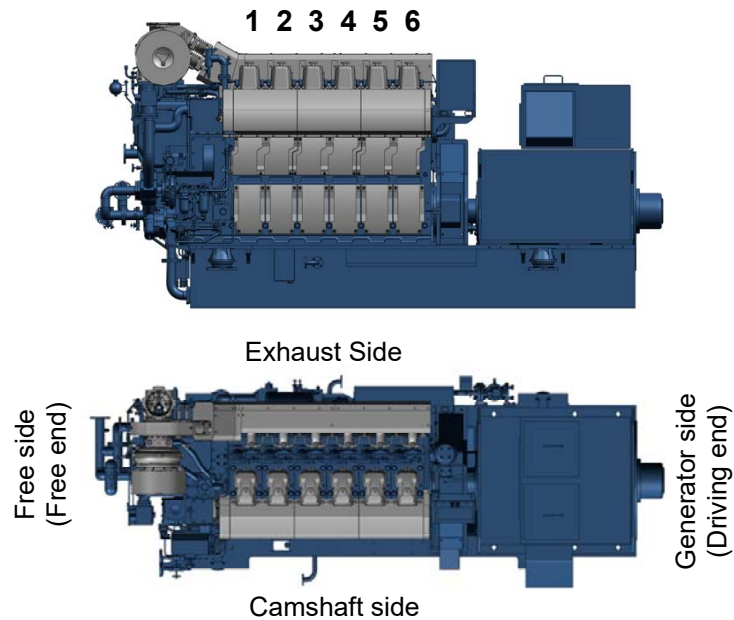

Figure 1.1 Cylinder numbering

1.2.2 Direction of engine rotation

Clockwise viewed from driving end.
Counter-clockwise viewed from free end.

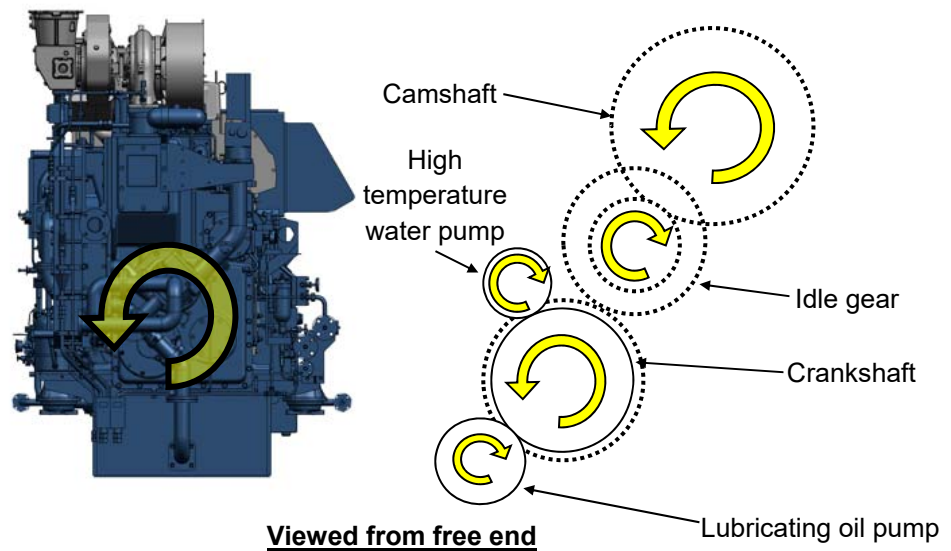

Figure 1.2 Direction of engine rotation

2 Structural design and installation

2.1 Principal data

Table 2.1 Principal data

Type of engine	4-stroke, vertical, direct injection, single acting and trunk piston type with turbocharger and inter-cooler.		
		H17/28U	H17/28E
Cylinder configuration		In-line	
Number of cylinder		6	
Rated speed	rpm	900 / 1000	
Power per cylinder	kW	134.2	110
Cylinder bore	mm	170	
Piston stroke	mm	280	
Swept Volume per cylinder	dm ³	6.36	
Mean piston speed	m/s	8.4 / 9.3	
Mean effective pressure	bar	28.1 / 25.1	23.1 / 20.8
Compression ratio		15 : 1	
Direction of engine rotation		Clockwise viewed from generator side (Non-reversible)	
Cylinder firing order		1 - 2 - 4 - 6 - 5 - 3	

2.2 Engine cross section

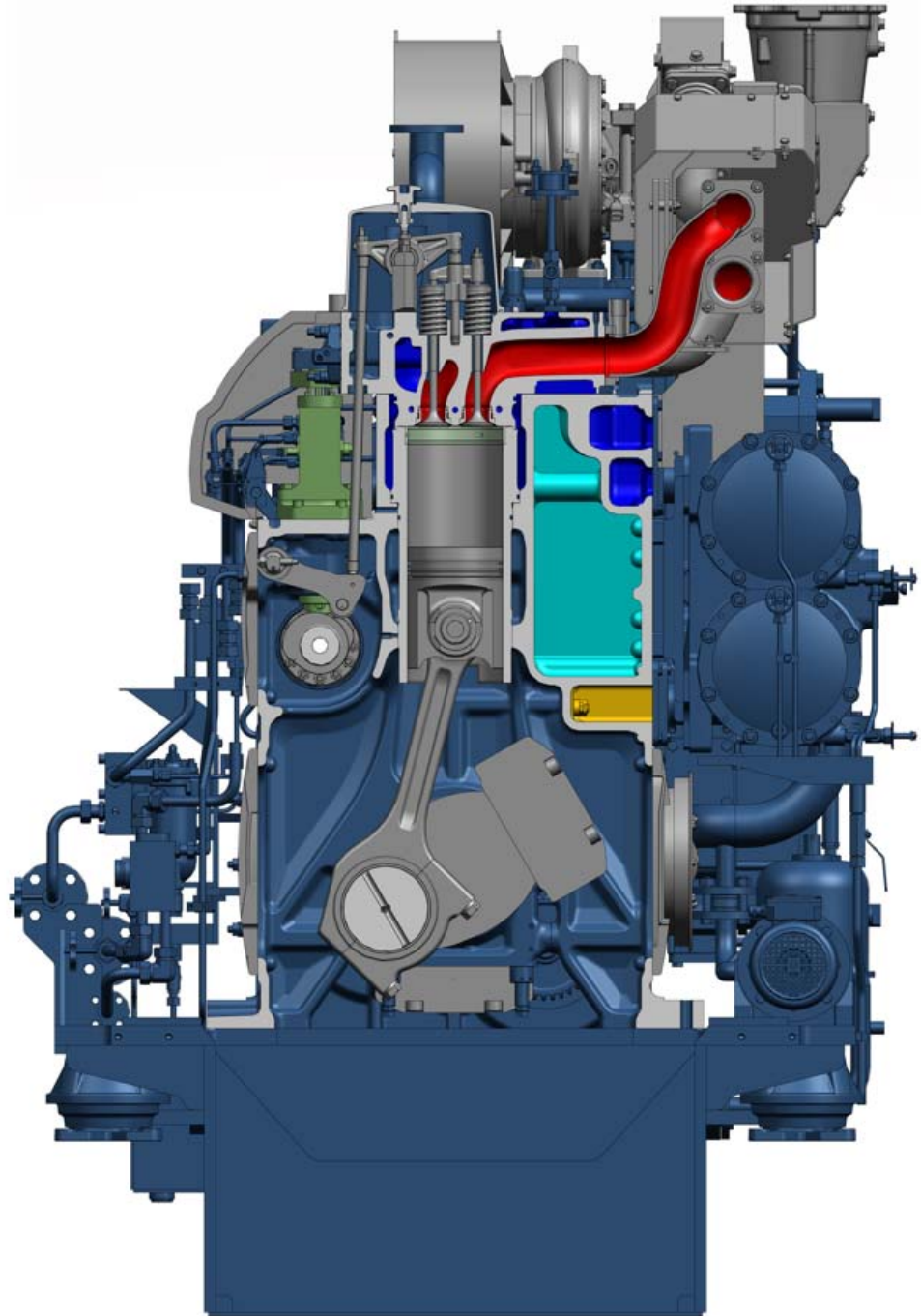

Figure 2.1 Engine cross section

2.3 Engine design outline

2.3.1 General

Hyundai engine 'HiMSEN H17/28E(U)' family have simple and smart design suitable for marine application with high reliability and performance. The key features are summarized as below :

1. Heavy fuel engine can be run with same fuel of main engine (Uni-fuel concept).
2. Eco-friendly and economical engine with the lowest fuel consumption and NO_x emission which are based on the following specific designs :
 - ✓ High stroke to bore ratio
 - ✓ Optimized combustion parameters
 - ✓ Optimized supercharging with miller cycle
 - ✓ High fuel injection pressure
3. Reliable and practical engine with simple, smart and robust structure.
 - ✓ A number of engine components are minimized with pipe-free design
 - ✓ Most of the components are directly accessible for easy maintenance

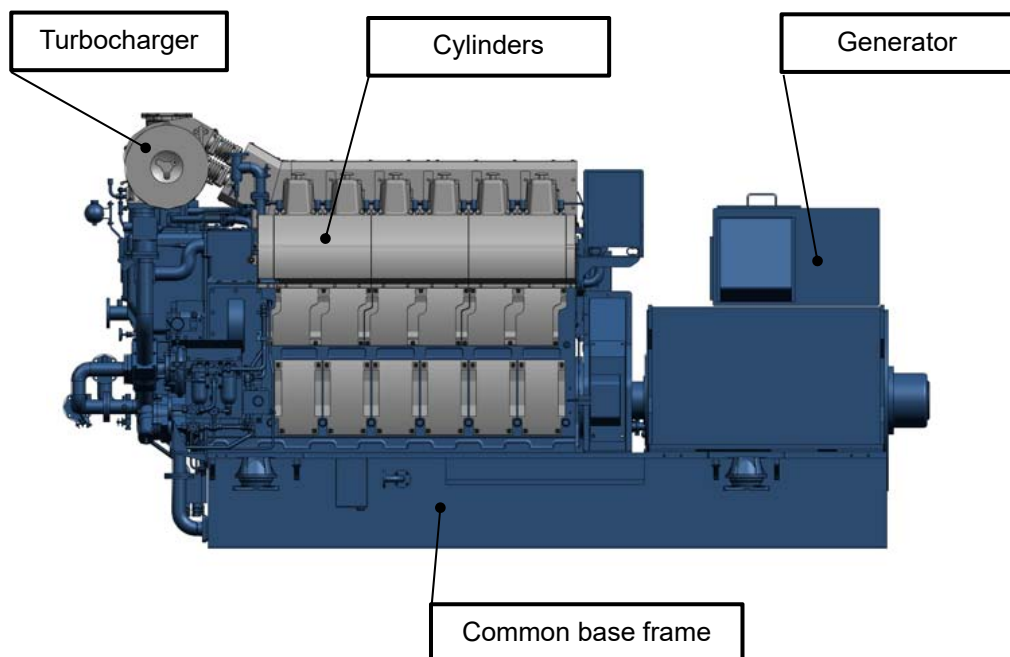

Figure 2.2 Engine design outline

2.3.2 Design of main components

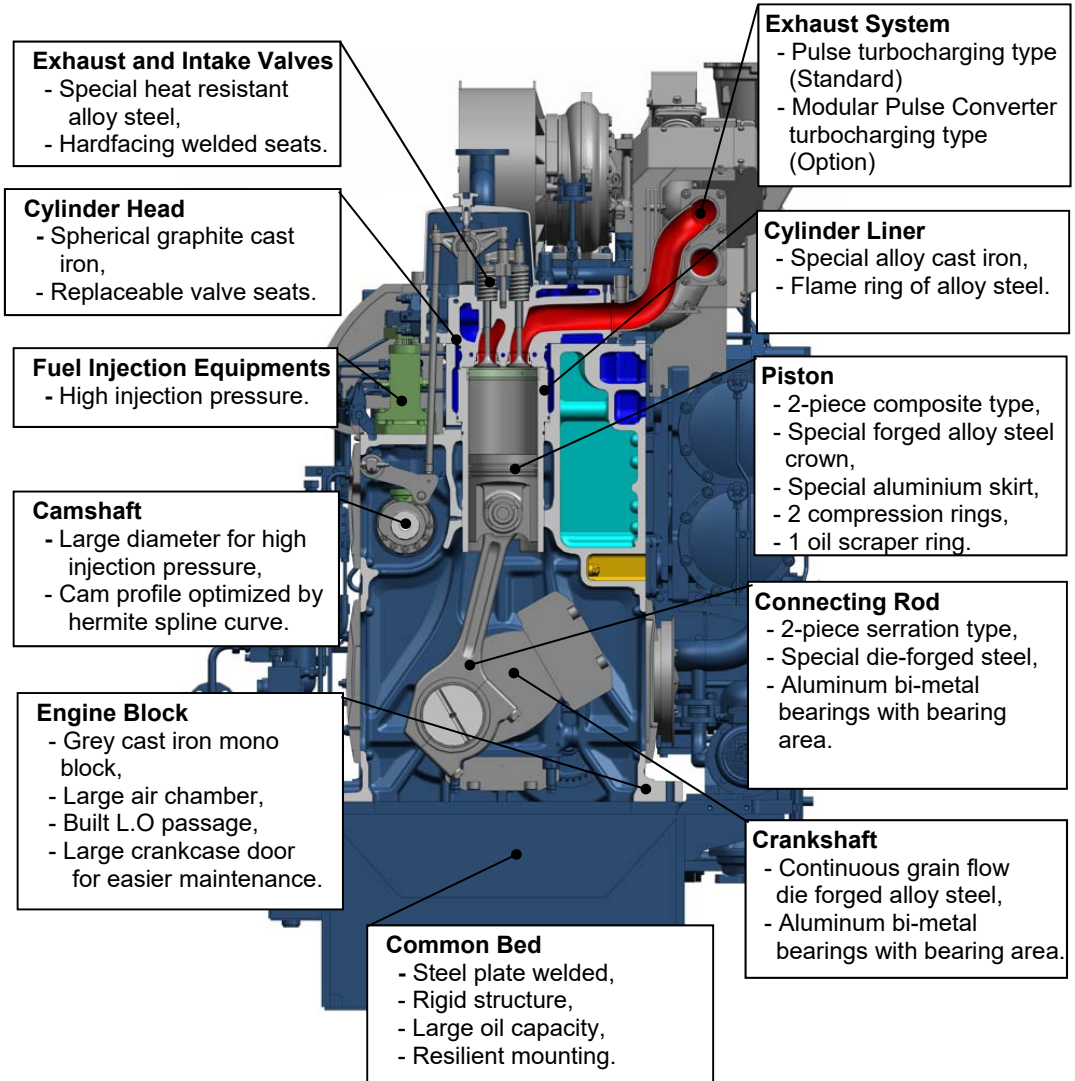

Figure 2.3 Cross section drawing

2.4 Generating-set dimension and weight

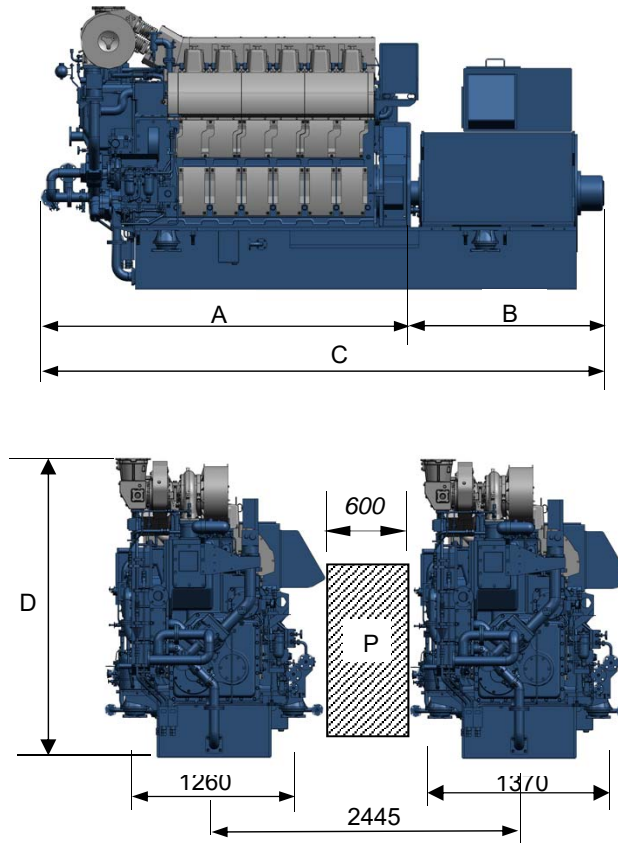

Table 2.2 Generating-set dimension and weight for 900 / 1000 rpm

Engine Type (kW)	Dimensions (mm)				Dry weight (ton) ²⁾	
	A	B ¹⁾	C ¹⁾	D	Engine ³⁾	Generating-set ⁴⁾
6H17/28U (805 kW)	2920	2069	4989	2393	7.1	13.8
6H17/28E (660 kW)	2920	1939	4859	2323	6.9	13.0

1. All dimensions and weight are approximate value and subject to change without prior notice.

1) : Depending on alternator.

2) : Weight including a standard alternator (Maker : HHI-EES)

3) : Without common base frame

4) : With common base frame and generator

P : Free passage between the engines, width 600 mm and height 2000 mm.

2.5 Mounting

2.5.1 General

The HiMSEN generating-set consists of diesel engine and alternator mounted on common base frame. The common base frame is installed on resilient mounts on the foundation in the ship.

The resilient mounting for the generating-set is made with a number of rubber elements in order to isolate from vibrations between generating-set and hull structure. These rubber elements are bolted to brackets of the common base frame as shown below Figure 2.4.

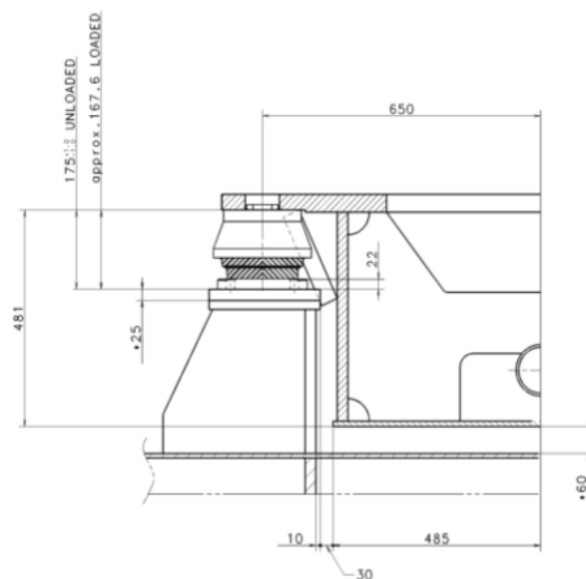

Figure 2.4 Resilient mounting

2.5.2 Design of resilient mount

The quantities and position of the resilient mount are determined by the dynamic characteristics of vessel. Therefore, the final specification of the resilient mount shall be decided based on the information from vessel contractor.

2.5.3 Connections to the generating-set

Generating-set mounted on resilient mount is usually influenced by a relative motions from the hull structure. Due to the reason, any rigid fixing between generating-set and hull structure causes damages to generating-set or hull. Therefore, all connections, for example, pipes, gratings, ladders, electric wires, etc., should be flexible enough to absorb the relative movements.

2.5.4 Recommendations for seating design and adjustment

The foundation for common base frame mounting should be rigid enough to support the load from generating-set. Steel shim plates with thickness of minimum 25 mm between rubber elements and foundation are required to adjust leveling of each mount (Method 1). Additional shim plate (Minimum thickness 10 mm) can be used for adjustments (Method 2) as shown below Figure 2.5.

(For the 25mm steel shim plate, it is necessary to use the divided internal buffer type resilient mounting). It is also recommended to check the crankshaft deflection before starting up the engine to secure the correct adjustments of the shim plate and leveling of the generating-set.

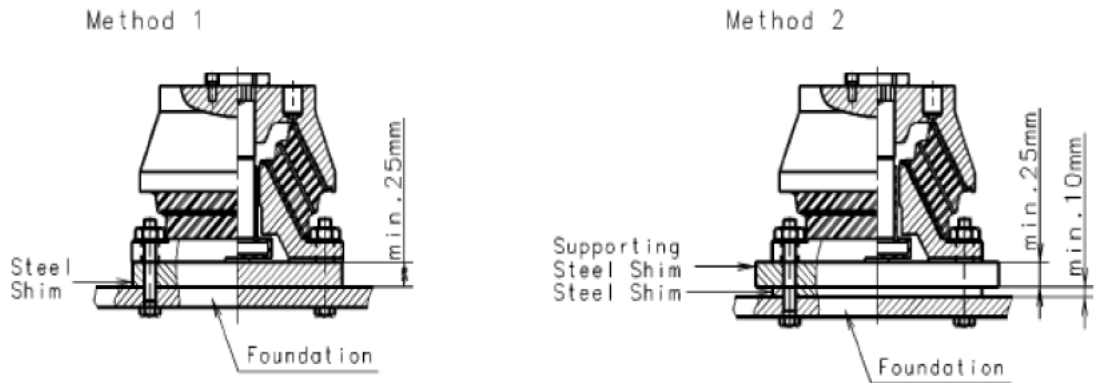

Figure 2.5 Recommendations for seating design

2.5.5 Recommendation of deck structure for resilient mounting

When the generating sets are installed on a deck structure, it is generally recommended to strength the deck by a longitudinal and transverse stiffener with the resilient mountings as shown as the below Figure 2.6.

It is generally recommended that the designs of the deck structure consider a sufficient stiffness and strength based on the actual deck load and to avoid the resonance with propulsion system.

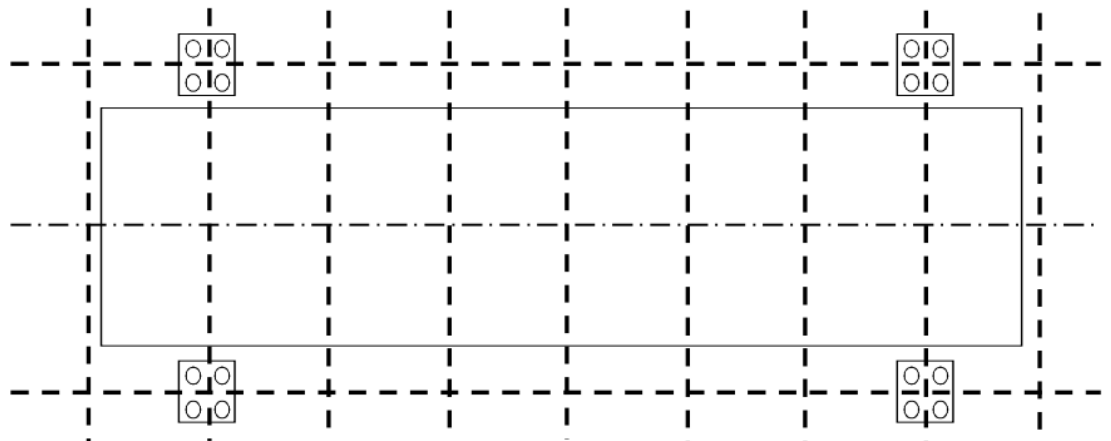

Figure 2.6 Deck structure for resilient mounting

2.6 Overhaul dimension

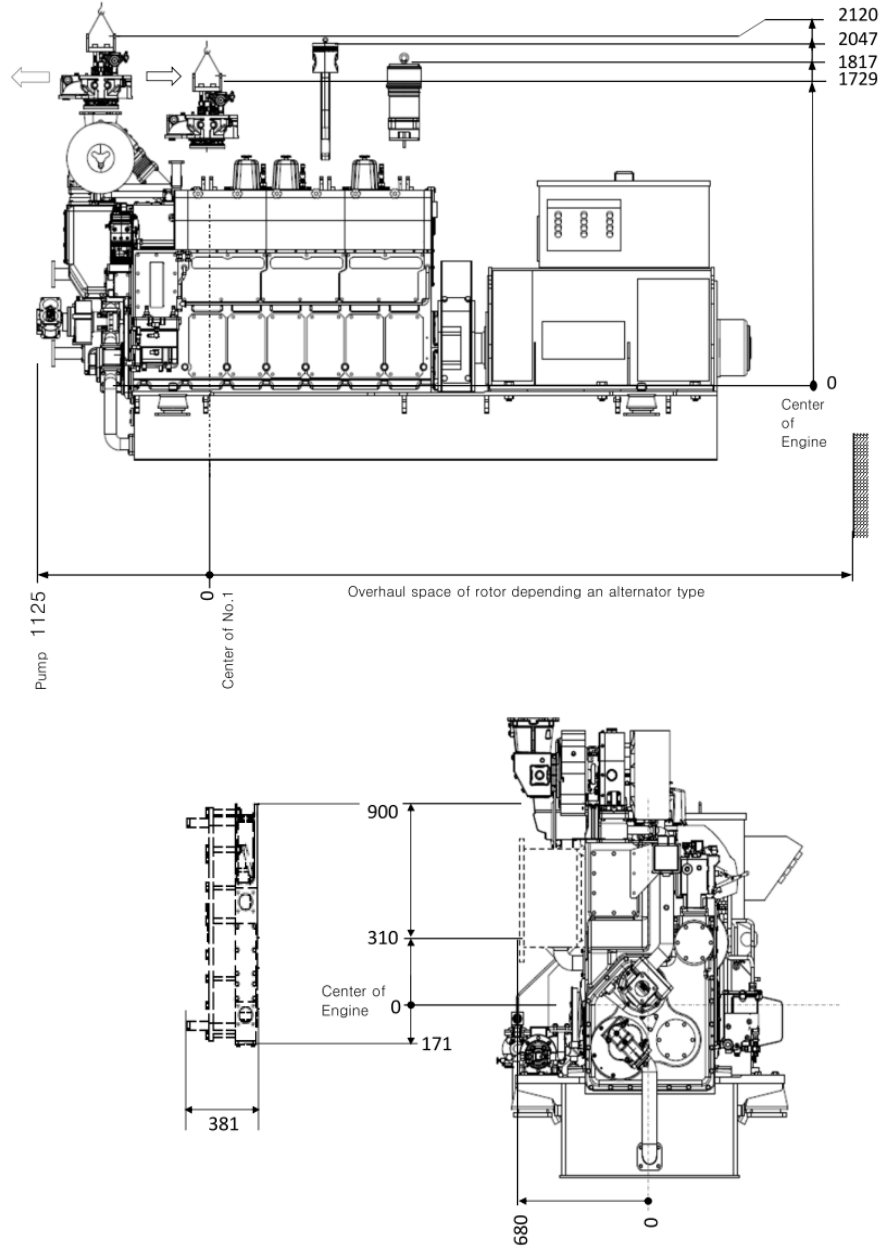

Figure 2.7 Overhaul dimension

3 Performance data

3.1 Rated power for generating-set

Table 3.1 Rated power for generating-set

Engine type	Rated output at			
	900 rpm / 60 Hz		1000 rpm / 50 Hz	
	Engine (kWm)	Generator (kWe)	Engine (kWm)	Generator (kWe)
6H17/28U	805	750	805	750
6H17/28E	660	618	660	618

1. The permissible overload is 10 % for one hour every twelve hours.
2. The alternator outputs are calculated for an efficiency of 93.2~94 % and a power factor of 0.8 lagging.
3. Power adjusting of diesel engines must be consulted to engine builder.

Reference condition

General definition of diesel engine rating is specified in accordance with ISO 3046-1.

ISO condition

Turbocharger air inlet pressure : 1000 mbar
 Intake air temperature : 298 K (25 °C)
 L.T cooling water temperature : 298 K (25 °C)

Tropical condition

Turbocharger air inlet pressure : 1000 mbar
 Intake air temperature : 318 K (45°C)
 L.T cooling water temperature : 309 K (36°C)

3.2 Engine capacity data

Table 3.2 Engine capacity data - (Rated power : 134.2 kW / cyl. & 110 kW / cyl. at 900 rpm)

Engine MCR	Cyl.	6H17/28U	6H17/28E
	KW	805 (134.2 kW/cylinder)	660 (110 kW/cylinder)
1. Cooling capacities			
Charge air			
Heat dissipation ¹⁾	kW	310	251
Low temperature cooling water flow	m ³ /h	30	30
Low cooling water temperature, cooler in / out	°C	36 / 45	36 / 43
Lubricating oil			
Heat dissipation ^{1) 3)}	kW	150	116
Low temperature cooling water flow	m ³ /h	30	30
Low cooling water temperature, cooler in / out	°C	45 / 49	43 / 46
Cylinder jacket			
Heat dissipation ¹⁾	kW	140	108
High temperature cooling water flow	m ³ /h	30	25
High cooling water temperature, engine in / out	°C	78 / 82	78 / 82
2. Gas data ²⁾			
Combustion air consumption	kg/h	5795	4820
Exhaust gas flow	kg/h	5950	4950
Exhaust gas temperature	°C	320	285
Allowable exhaust gas back pressure max.	mbar	30	30
3. Heat radiation			
Engine radiation ¹⁾	kW	20	15
Alternator radiation	kW	(See separate data from alternator maker)	

Engine MCR	Cyl.	6H17/28U	6H17/28E
	kW	805 (134.2 kW/cylinder)	660 (110 kW/cylinder)

4. Starting air

Air consumption per start ⁷⁾	Nm ³	2.73	2.73
Starting air source, pressure max. / min.	bar	30 / 10	30 / 10

5. Pump capacities

Engine driven pumps ⁴⁾

Lubricating oil pump (6 bar)	m ³ /h	32	26
High temperature cooling water pump (1 ~ 2.5 bar)	m ³ /h	30	30
Low temperature cooling water pump (1 ~ 2.5 bar)	m ³ /h	30	25

External pumps ⁵⁾

Marine diesel oil pump (head) - (8 bar)	m ³ /h	0.55	0.45
Heavy fuel oil supply pump (head) - (4 bar)	m ³ /h	0.28	0.23
Heavy fuel oil booster pump (8 bar at engine inlet, F1) ⁶⁾	m ³ /h	0.55	0.45

Remarks

- 1) Under tropical condition (Turbocharger air inlet pressure 1 bar, intake air temperature 45°C, LT-cooling water temperature 36°C) with tolerance 10%.
- 2) Under ISO condition (ISO 3046-1:2002, Turbocharger air inlet pressure 1 bar, intake air temperature 25°C, LT-cooling water temperature 25°C) with flow tolerance ±5% and exhaust gas temperature tolerance ±25°C.
- 3) Additional heat for lube oil purification should be included. (30 kJ/kWh).
- 4) Flow capacity to be within a tolerance of 0 % to + 10 %.
- 5) Flushing oil quantity of automatic filter is included.
- 6) Heavy fuel oil booster pump head to be designed by external system designer considering pressure loss of external system.
- 7) This value includes Jet Assist System consumption. The air amount of jet assist for sudden load to be adjusted depending on the loading condition.

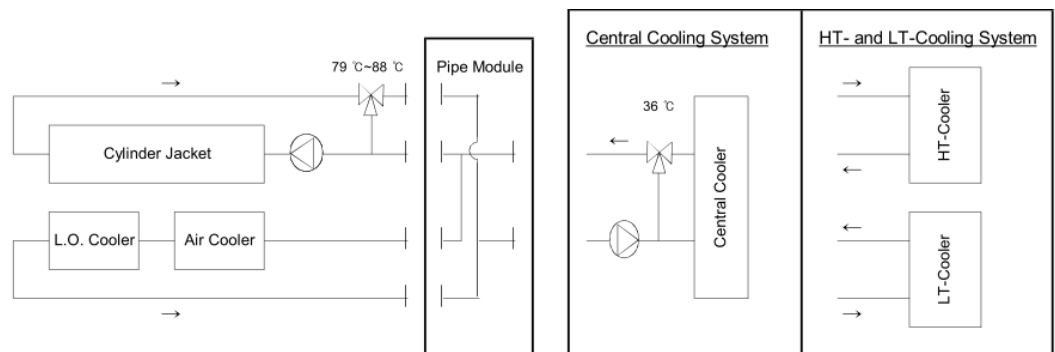

Figure 3.1 Cooling system arrangement

Table 3.3 Engine capacity data – (Rated power : 134.2 kW / cyl. & 110 kW / cyl. at 1000 rpm)

Engine MCR	Cyl.	6H17/28U	6H17/28E
	KW	805 (134.2 kW/cylinder)	660 (110 kW/cylinder)
1. Cooling capacities			
Charge air			
Heat dissipation ¹⁾	kW	325	251
Low temperature cooling water flow	m ³ /h	30	30
Low cooling water temperature, cooler in / out	°C	36 / 45	36 / 43
Lubricating oil			
Heat dissipation ^{1) 3)}	kW	145	116
Low temperature cooling water flow	m ³ /h	30	30
Low cooling water temperature, cooler in / out	°C	45 / 49	43 / 46
Cylinder jacket			
Heat dissipation ¹⁾	kW	135	108
High temperature cooling water flow	m ³ /h	30	25
High cooling water temperature, engine in / out	°C	78 / 82	78 / 82
2. Gas data ²⁾			
Combustion air consumption	kg/h	5940	4820
Exhaust gas flow	kg/h	6095	4950
Exhaust gas temperature	°C	305	295
Allowable exhaust gas back pressure max.	mbar	30	30
3. Heat radiation			
Engine radiation ¹⁾	kW	20	15
Alternator radiation	kW	(See separate data from alternator maker)	

Engine MCR	Cyl.	6H17/28U	6H17/28E
	kW	805 (134.2 kW/cylinder)	660 (110 kW/cylinder)

4. Starting air

Air consumption per start ⁷⁾	Nm ³	2.73	2.73
Starting air source, pressure max. / min.	bar	30 / 10	30 / 10

5. Pump capacities

Engine driven pumps ⁴⁾

Lubricating oil pump (6 bar)	m ³ /h	36	29
High temperature cooling water pump (1 ~ 2.5 bar)	m ³ /h	30	30
Low temperature cooling water pump (1 ~ 2.5 bar)	m ³ /h	30	25

External pumps ⁵⁾

Marine diesel oil pump (head) - (8 bar)	m ³ /h	0.55	0.45
Heavy fuel oil supply pump (head) - (4 bar)	m ³ /h	0.28	0.23
Heavy fuel oil booster pump (8 bar at engine inlet, F1) ⁶⁾	m ³ /h	0.55	0.45

Remarks

- 1) Under tropical condition (Turbocharger air inlet pressure 1 bar, intake air temperature 45°C, LT-cooling water temperature 36°C) with tolerance 10%.
- 2) Under ISO condition (ISO 3046-1:2002, Turbocharger air inlet pressure 1 bar, intake air temperature 25°C, LT-cooling water temperature 25°C) with flow tolerance ±5% and exhaust gas temperature tolerance ±25°C.
- 3) Additional heat for lube oil purification should be included. (30 kJ/kWh).
- 4) Flow capacity to be within a tolerance of 0 % to + 10 %.
- 5) Flushing oil quantity of automatic filter is included.
- 6) Heavy fuel oil booster pump head to be designed by external system designer considering pressure loss of external system.
- 7) This value includes Jet Assist System consumption. The air amount of jet assist for sudden load to be adjusted depending on the loading condition.

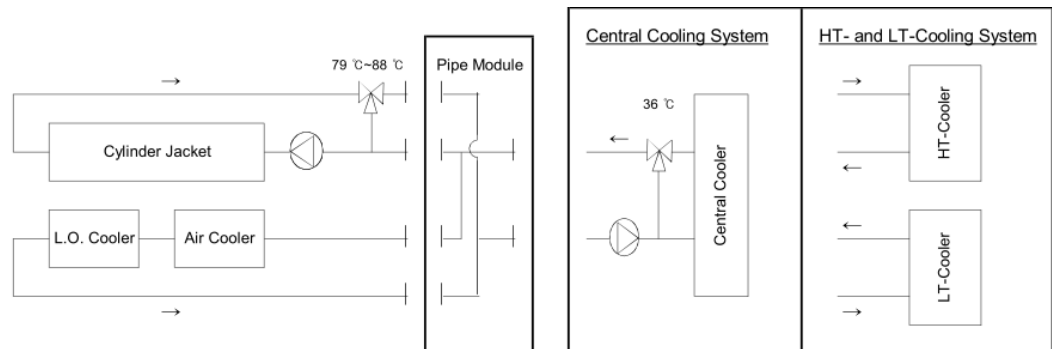

Figure 3.2 Cooling system arrangement

3.3 Engine performance

Table 3.4 Engine performance data – H17/28E (Rated power : 110 kW / cylinder at 900 rpm)

Performance data		Engine load (%)					
		110	100	90	75	50	25
1. Cylinder data							
Cylinder output	kW	121	110	99	82.5	55	27.5
Mean effective pressure	bar	25.4	23.1	20.8	17.3	11.5	5.8
2. Combustion air data ¹⁾							
Mass flow	kg/kWh	7.0	7.3	7.4	7.6	8.2	9.6
Air Temperature after cooler	°C	45	45	45	45	45	45
3. Exhaust gas data ¹⁾							
Mass flow	kg/kWh	7.2	7.5	7.6	7.8	8.4	9.8
Gas temperature after turbine	°C	285	285	290	305	330	350
4. Heat balance data ²⁾							
Charge air	kJ/kWh	1420	1370	1310	1160	900	425
Lubricating oil	kJ/kWh	650	635	635	725	935	1315
Jacket cooling water	kJ/kWh	590	585	590	605	770	1410
Radiation	kJ/kWh	95	85	90	105	145	355
5. Specific fuel oil consumption ³⁾							
Specific fuel oil consumption	g/kWh	192.2	189	189.3	191.5	205.4	237.4

Remarks

Reference condition is based on ISO 3046-1:2002 (turbocharger air inlet pressure 1 bar, intake air temperature 25°C, L.T cooling water temperature 25°C) except heat balance data. For heat balance data, please see No. 2). The above values are based on IMO Tier II emission level without selective catalyst reduction operation.

- 1) Mass flow tolerance $\pm 5\%$, temperature tolerance $\pm 25^\circ\text{C}$ (50% < load \leq 110%).
 Mass flow tolerance $\pm 10\%$, temperature tolerance $\pm 35^\circ\text{C}$ (Load \leq 50%).
 For heat recovery, additional temperature tolerance - 10°C should be accounted.
 When calculating heat dissipation for heat recovery based on the mass flow & temperature, the mass flow & temperature's tolerance should be considered.

- 2) Reference condition is based on tropical condition (turbocharger air inlet pressure 1 bar, intake air temperature 45°C, L.T cooling water temperature 36°C).
Heat dissipation tolerance + 10 % for cooler, - 15 % for heat recovery.
Additional heat for lube oil purification should be included. (30 kJ/kWh).
- 3) Specific fuel oil consumption tolerance + 5 % at 100 % load.
Engine driven pumps detached : lubricating oil pump, high temperature cooling water pump, low temperature cooling water pump.
Specific fuel oil consumption excludes clean leakage fuel oil.
Fuel oil based on marine diesel oil, lower calorific value 42700 kJ/kg.
Specific fuel oil consumption is warranted at 100 % engine load without selective catalyst reduction operation.

Note) The value are only reference, the values can be modified.

Table 3.5 Engine performance data – H17/28E (Rated power : 110 kW / cylinder at 1000 rpm)

Performance data		Engine load (%)					
		110	100	90	75	50	25
1. Cylinder data							
Cylinder output	kW	121	110	99	82.5	55	27.5
Mean effective pressure	bar	25.4	23.1	20.8	17.3	11.5	5.8
2. Combustion air data ¹⁾							
Mass flow	kg/kWh	7.0	7.3	7.4	7.6	8.2	9.6
Air Temperature after cooler	°C	45	45	45	45	45	45
3. Exhaust gas data ¹⁾							
Mass flow	kg/kWh	7.2	7.5	7.6	7.8	8.4	9.8
Gas temperature after turbine	°C	295	295	300	315	340	360
4. Heat balance data ²⁾							
Charge air	kJ/kWh	1420	1370	1305	1160	900	425
Lubricating oil	kJ/kWh	655	635	640	725	940	1320
Jacket cooling water	kJ/kWh	590	590	595	610	775	1415
Radiation	kJ/kWh	95	85	90	105	145	355
5. Specific fuel oil consumption ³⁾							
Specific fuel oil consumption	g/kWh	193.2	190	190.3	192.5	206.4	238.4

Remarks

Reference condition is based on ISO 3046-1:2002 (turbocharger air inlet pressure 1 bar, intake air temperature 25°C, L.T cooling water temperature 25°C) except heat balance data. For heat balance data, please see No. 2). The above values are based on IMO Tier II emission level without selective catalyst reduction operation.

1) Mass flow tolerance ± 5 %, temperature tolerance ± 25°C (50 % < load ≤ 110 %).

Mass flow tolerance ± 10 %, temperature tolerance ± 35°C (Load ≤ 50%).

For heat recovery, additional temperature tolerance - 10°C should be accounted.

When calculating heat dissipation for heat recovery based on the mass flow & temperature, the mass flow & temperature's tolerance should be considered.

2) Reference condition is based on tropical condition (turbocharger air inlet pressure 1 bar, intake air temperature 45°C, L.T cooling water temperature 36°C).

Heat dissipation tolerance + 10 % for cooler, - 15 % for heat recovery.

Additional heat for lube oil purification should be included. (30 kJ/kWh).

- 3) Specific fuel oil consumption tolerance + 5 % at 100 % load.
Engine driven pumps detached : lubricating oil pump, high temperature cooling water pump, low temperature cooling water pump.
Specific fuel oil consumption excludes clean leakage fuel oil.
Fuel oil based on marine diesel oil, lower calorific value 42700 kJ/kg.
Specific fuel oil consumption is warranted at 100 % engine load without selective catalyst reduction operation.

Note) The value are only reference, the values can be modified.

Table 3.6 Engine performance data – H17/28U (Rated power : 134.2 kW / cylinder at 900 rpm)

Performance data		Engine load (%)					
		110	100	90	75	50	25
1. Cylinder data							
Cylinder output	kW	148	134	121	101	67	34
Mean effective pressure	bar	31.0	28.1	25.3	21.1	14.1	7.0
2. Combustion air data ¹⁾							
Mass flow	kg/kWh	7.2	7.2	7.3	7.3	7.5	7.7
Air Temperature after cooler	°C	45	45	45	45	45	45
3. Exhaust gas data ¹⁾							
Mass flow	kg/kWh	7.4	7.4	7.4	7.5	7.7	7.9
Gas temperature after turbine	°C	320	320	330	340	370	385
4. Heat balance data ²⁾							
Charge air	kJ/kWh	1480	1390	1280	1110	765	365
Lubricating oil	kJ/kWh	680	670	670	755	950	1270
Jacket cooling water	kJ/kWh	615	620	620	630	780	1365
Radiation	kJ/kWh	100	90	90	110	145	345
5. Specific fuel oil consumption ³⁾							
Specific fuel oil consumption	g/kWh	192	191	191	192	201	220

Remarks

Reference condition is based on ISO 3046-1:2002 (turbocharger air inlet pressure 1 bar, intake air temperature 25°C, L.T cooling water temperature 25°C) except heat balance data. For heat balance data, please see No. 2). The above values are based on IMO Tier II emission level without selective catalyst reduction operation.

1) Mass flow tolerance ± 5 %, temperature tolerance ± 25°C (50 % < load ≤ 110 %).

Mass flow tolerance ± 10 %, temperature tolerance ± 35°C (Load ≤ 50%).

For heat recovery, additional temperature tolerance - 10°C should be accounted.

When calculating heat dissipation for heat recovery based on the mass flow & temperature, the mass flow & temperature's tolerance should be considered.

2) Reference condition is based on tropical condition (turbocharger air inlet pressure 1 bar, intake air temperature 45°C, L.T cooling water temperature 36°C).

Heat dissipation tolerance + 10 % for cooler, - 15 % for heat recovery.

Additional heat for lube oil purification should be included. (30 kJ/kWh).

- 3) Specific fuel oil consumption tolerance + 5 % at 100 % load.
Engine driven pumps detached : lubricating oil pump, high temperature cooling water pump, low temperature cooling water pump.
Specific fuel oil consumption excludes clean leakage fuel oil.
Fuel oil based on marine diesel oil, lower calorific value 42700 kJ/kg.
Specific fuel oil consumption is warranted at 100 % engine load without selective catalyst reduction operation.

Note) The value are only reference, the values can be modified.

Table 3.7 Engine performance data – H17/28U (Rated power : 134.2 kW / cylinder at 1000 rpm)

Performance data		Engine load (%)					
		110	100	90	75	50	25
1. Cylinder data							
Cylinder output	kW	148	134	121	101	67	34
Mean effective pressure	bar	27.9	25.3	22.8	19.0	12.7	6.3
2. Combustion air data ¹⁾							
Mass flow	kg/kWh	7.3	7.4	7.4	7.5	7.7	7.9
Air Temperature after cooler	°C	45	45	45	45	45	45
3. Exhaust gas data ¹⁾							
Mass flow	kg/kWh	7.5	7.6	7.6	7.7	7.9	8.1
Gas temperature after turbine	°C	305	305	310	320	340	370
4. Heat balance data ²⁾							
Charge air	kJ/kWh	1540	1450	1330	1150	785	375
Lubricating oil	kJ/kWh	670	660	660	750	935	1255
Jacket cooling water	kJ/kWh	605	610	615	625	770	1345
Radiation	kJ/kWh	100	90	95	110	145	345
5. Specific fuel oil consumption ³⁾							
Specific fuel oil consumption	g/kWh	192	191	191	192	201	220

Remarks

Reference condition is based on ISO 3046-1:2002 (turbocharger air inlet pressure 1 bar, intake air temperature 25°C, L.T cooling water temperature 25°C) except heat balance data. For heat balance data, please see No. 2). The above values are based on IMO Tier II emission level without selective catalyst reduction operation.

1) Mass flow tolerance ± 5 %, temperature tolerance ± 25°C (50 % < load ≤ 110 %).

Mass flow tolerance ± 10 %, temperature tolerance ± 35°C (Load ≤ 50%).

For heat recovery, additional temperature tolerance - 10°C should be accounted.

When calculating heat dissipation for heat recovery based on the mass flow & temperature, the mass flow & temperature's tolerance should be considered.

2) Reference condition is based on tropical condition (turbocharger air inlet pressure 1 bar, intake air temperature 45°C, L.T cooling water temperature 36°C).

Heat dissipation tolerance + 10 % for cooler, - 15 % for heat recovery.

Additional heat for lube oil purification should be included. (30 kJ/kWh).

- 3) Specific fuel oil consumption tolerance + 5 % at 100 % load.
Engine driven pumps detached : lubricating oil pump, high temperature cooling water pump, low temperature cooling water pump.
Specific fuel oil consumption excludes clean leakage fuel oil.
Fuel oil based on marine diesel oil, lower calorific value 42700 kJ/kg.
Specific fuel oil consumption is warranted at 100 % engine load without selective catalyst reduction operation.

Note) The value are only reference, the values can be modified.

3.4 Exhaust gas emission

3.4.1 General

HiMSEN H17/28E(U) is designed for environment-friendly engine and complies with the IMO NO_x emission limits with low fuel consumption and less smoke.

Typical composition of exhaust gas emission in volume ratio at full load are as follows:

Table 3.8 Typical compositions of exhaust gas emission

Typical exhaust compositions	Volume[%]
Nitrogen, N ₂	approx. 73
Oxygen, O ₂	approx. 13
Carbon Dioxide, CO ₂	approx. 6
Water (Vapor), H ₂ O	approx. 6
Argon, Ar	approx. 1
Soot, Ash, NO _x , CO, HC, etc.	residue

Residue is little in amount but ecologically critical. Therefore, a careful attention on the treatment of fuel oil shall be required for engine operating conditions.

If there is no special requirements from customer regarding the exhaust gas emission, HiMSEN Generating-set shall be delivered with optimized performance conditions fulfilling the MARPOL 73/78 ANNEX VI, Regulation 13 of value of NO_x emissions.

Therefore, it is strongly requested to contact the engine maker if there are any further requirements regarding exhaust gas emission or special operating conditions.

3.4.2 Engine international air pollution prevention (EIAPP) certificates

The Engine International Air Pollution Prevention (EIAPP) certificate is related to NO_x emissions. If an engine complies with the NO_x emission limits defined in regulation 13 of Annex VI, the EIAPP certificate with approved NO_x technical file shall be issued by the administration or organization on behalf of the administration. Those are necessary for renewal of EIAPP certificate through the on-board NO_x verification. The approved NO_x technical file and EIAPP certificate shall accompany the engine throughout its life and shall be available at all times on the ship.

IMO tier II and tier III limits (MARPOL ANNEX VI (73/78))

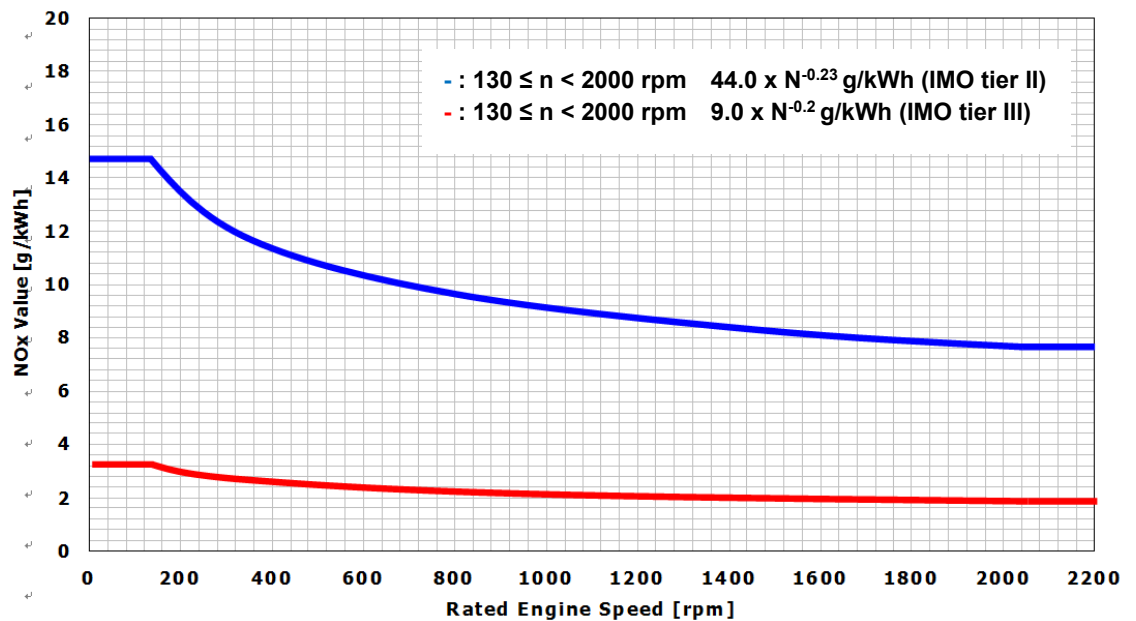

NO_x Emission from marine diesel engine test Cycle D2
In accordance with ISO 8178-4 and IMO NO_x technical code

Figure 3.3 IMO tier II and tier III limits

3.5 Power de-rating diagram

3.5.1 Diesel operation

De-rating due to Intake air temperature, cooling water temperature and altitude

Engine output power at maximum continuous rating shall be reduced depending on the intake air temperature, cooling water temperature and site altitude.

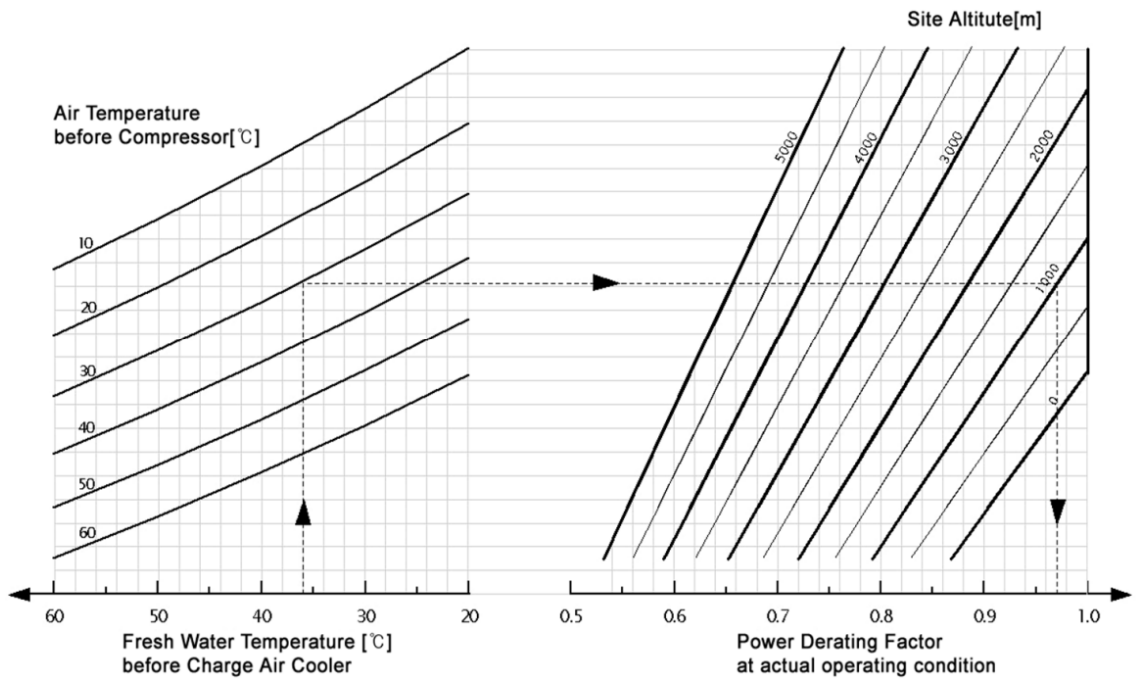

Figure 3.4 De-rating due to intake air temperature, cooling water temperature and altitude

Example

Cooling water temperature before charge air cooler : 36 °C

Intake air temperature : 30 °C

Site altitude : 1000 m

From the power de-rating diagram, the power de-rating factor at actual operating condition is 0.97. Therefore the engine output power at actual operating condition should be de-rated to the 97 % of the standard engine rated power.

3.6 Correction of fuel oil consumption

3.6.1 Correction of ambient condition

Specific Fuel Oil Consumption (SFOC) is referred to the ISO 3046-1 standard condition in normally.

However, for the condition other than ISO 3046-1:2002 standard condition, the SFOC at maximum continuous rating can be estimated according to the below formula.

$$\text{SFOC}_{\text{amb}} = \text{SFOC}_{\text{ISO}} \times d\text{SFOC}$$

$$d\text{SFOC} = [100 + (T_{\text{intake}} - 25) \times 0.05 - (P_{\text{amb}} - 1000) \times 0.007 + (T_{\text{cw}} - 25) \times 0.07] / 100 \times (42700 / \text{LCV})$$

Where :

SFOC_{amb} (g/kWh) : Specific fuel oil consumption at actual operating condition

SFOC_{ISO} (g/kWh) : Specific fuel oil consumption at ISO 3046-1 standard condition

$d\text{SFOC}$ (-) = deviation of the specific fuel oil consumption

T_{intake} (°C) : Intake air temperature at actual operating condition

P_{amb} (mbar) : Turbocharger inlet air pressure at actual operating condition

T_{cw} (°C) : Cooling water temperature before charge air cooler at actual operating condition

LCV (kJ/kg) : Lower calorific value of the fuel oil

Example,

Intake air temperature (T_{intake}) : 30 °C,

P_{amb} : 1000 (mbar)

Cooling water temperature (T_{cw}) : 30 °C

Lower calorific value (LCV) : 42700 kJ/kg

SFOC_{ISO} : 183 g/kWh at 720 rpm, maximum continuous rating

then, $d\text{SFOC} = 1.006$ and the SFOC at site condition will be increased to 184.1 g/kWh.

3.6.2 Clean leak fuel oil

Clean leak fuel oil (recycling fuel oil) during engine operation is subtracted from measured fuel oil consumption.

(Refer to 6.1 Internal fuel oil system)

$$\text{FOC}_{\text{amb}} = \text{FOC} - \text{clean leak fuel oil}^*)$$

*) The FOC and clean leak fuel oil (kg/h) are measured over minimum 10 mins.

3.6.3 Correction of additional fuel oil consumption

If additional devices are attached on the engine or operation fuel is changed, the specific fuel oil consumption at maximum continuous rating will be increased as follows approximately:

Table 3.9 Correction of additional fuel consumption

Item	Additional SFOC [g/kWh]
Lubricating oil pump	+ 2
Low temperature cooling water pump.	+ 1
High temperature cooling water pump	+ 1
Fuel oil feed pump	Contact to HHI-EMD
Charge air pressure control device	Contact to HHI-EMD
Operation with marine gas oil	+ 2
500 mmWC > Exhaust gas back pressure after turbine > 300 mmWC	+ 0.5 / 100 mmWC

When low and high temperature cooling water pump is attached on engine,
Additional specific fuel oil consumption by water pump

$$= \text{Additional specific fuel oil consumption at 100 \% load} \times \left(\frac{100}{\text{load}}\right)^x \times \left(\frac{\text{actual rpm}}{\text{nominal rpm}}\right)^3 \text{ g/kWh}$$

When lubricating oil pump is attached on engine,
Additional specific fuel oil consumption by lubricating pump

$$= \text{Additional specific fuel oil consumption at 100 \% load} \times \left(\frac{100}{\text{load}}\right)^x \times \left(\frac{\text{actual rpm}}{\text{nominal rpm}}\right) \text{ g/kWh}$$

Table 3.10 Additional specific fuel oil consumption of each load

Load	100 ~ 25 %	Under 25 %
x	1.15	1.28

3.7 Correction of exhaust gas temperature

3.7.1 General

Correction for ambient condition

Exhaust gas temperature after turbine is referred to ISO 3046-1 standard condition in normally.

However, for the condition other than ISO 3046-1 standard condition, the exhaust gas temperature after turbine could be estimated according to the below formula :

$$T_{\text{exh.amb}} = T_{\text{exh.ISO}} + dT_{\text{exh}}$$

$$dT_{\text{exh}} = (T_{\text{intake}} - 25) \times 1.5 + (T_{\text{cw}} - 25) \times 0.7$$

where :

$T_{\text{exh.amb}}$ (°C) : Exhaust gas temperature after turbine at actual operating condition

$T_{\text{exh.ISO}}$ (°C) : Exhaust gas temperature after turbine at ISO 3046-1 standard condition

dT_{exh} (°C) : Deviation of the exhaust gas temperature after turbine

T_{intake} (°C) : Intake air temperature at actual operating condition

T_{cw} (°C) : Cooling water temperature before charge air cooler at actual operating condition

Example,

Intake air temperature (T_{intake}) : 35 °C

Cooling water temperature (T_{cw}) : 35 °C

$T_{\text{exh.ISO}}$: 290 °C at 720 rpm, maximum continuous rating

then, $dT_{\text{exg}} = 22$ °C and the $T_{\text{exh.amb}}$ at actual operating condition will be increased to 312 °C.

This page is intentionally blanked

4 Dynamic characteristics and noise

4.1 External forces and couples

Table 4.1 External forces and couples

Engine type	Speed	External forces and moments				Guide force moments		
		Order		Moment		Order		Moment
	Horizontal			Vertical				
	rpm	No.	Hz	kNm	kNm	No.	Hz	kNm
6H17/28U	900	1	15.0	0	0.0	3	45.0	12.3
		2	30.0	0	0.0	6	90.0	4.4
	1000	1	16.7	0	0.0	3	50.0	11.4
		2	33.3	0	0.0	6	100.0	4.4
6H17/28E	900	1	15.0	0	0.0	3	45.0	9.8
		2	30.0	0	0.0	6	90.0	3.5
	1000	1	16.7	0	0.0	3	50.0	8.8
		2	33.3	0	0.0	6	100.0	3.3

4.2 Moment of inertia

Table 4.2 Moment of inertia

Engine type	Speed	Rating	Moments of inertia ; J ₁)				
			Engine MOI	Flywheel		Alternator MOI ₂)	Total MOI
	MOI	Mass					
	rpm	kW	kgm ²	kgm ²	kg	kgm ²	kgm ²
6H17/28U	900	798	19.8	95.0	647.0	59.3	174.1
	1000	798	17.8	95.0	647.0	59.3	172.1
6H17/28E	900	660	19.8	70.0	498.4	54.4	144.2
	1000	660	17.8	70.0	498.4	54.4	142.2

1) Moment of Inertia : $GD^2 = 4 \times J$ (kgm²)

2) Recommended values, the case of different MOI should be confirmed by a torsional vibration analysis.

4.3 Noise measurement

4.3.1 General description

The airborne noise and air intake noise of the engine are defined as a sound pressure level according to ISO 6798 and ISO 8528-10. The total 19 point at distance 1 m away from the engine surface at full load should be measured. The values are averaged with A-weighting in one octave band.

In the octave level diagram, the minimum and maximum octave levels of all measuring points have been linked by results. The data can be changed, depending on the acoustical properties of the environment and the number of cylinder.

900 rpm (6 cylinder)

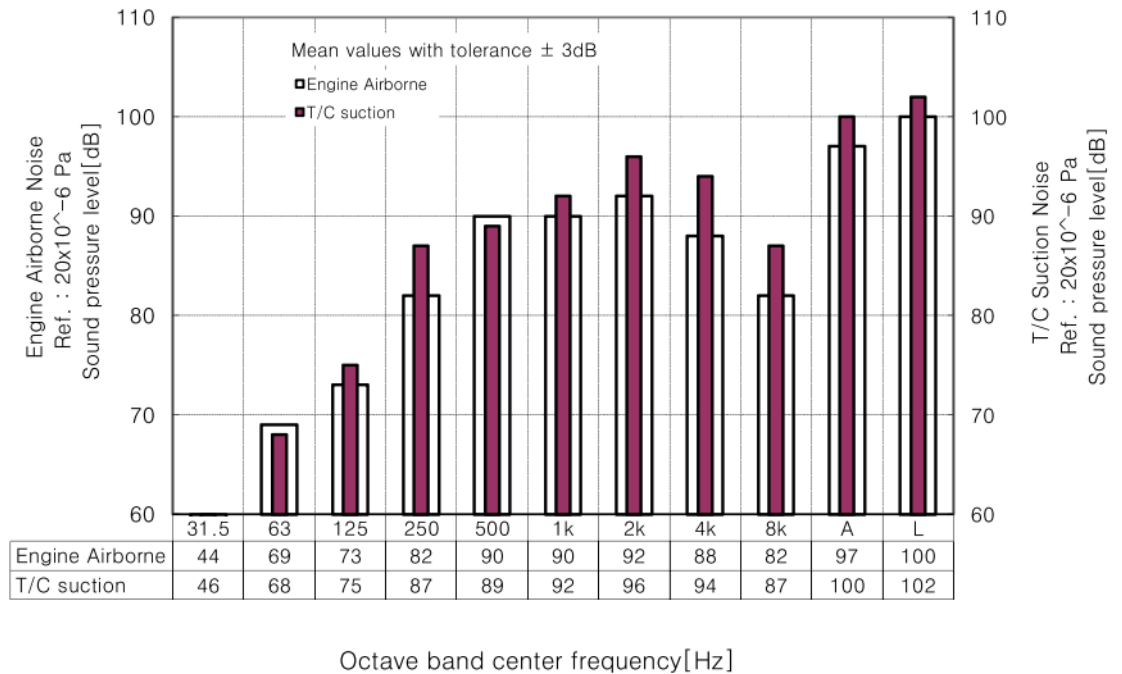

Figure 4.1 Engine air airborne noise level (900 rpm)

This page is intentionally blanked

5 Operation and control system

5.1 Engine operation

5.1.1 General

HiMSEN is a heavy fuel engine and it is not necessary to change over to diesel fuel at any operating condition, for example, engine start, stop, low load running, etc.

However, there are some recommended to maintain good performance and reliability consistently.

5.1.2 Starting condition

Normal starting condition

Lubricating oil

- ✓ Continuous pre-lubrication is required
- ✓ Temperature : over 40 °C (Preheated)

Cylinder cooling water

- ✓ Start on marine diesel oil / marine gas oil : over 40 °C (Preheated)
- ✓ Start on heavy fuel oil : over 60 °C (Preheated)

Combustion air

- ✓ Intake air temperature : between 0 °C and 45 °C

Starting air

- ✓ Refer to the sheet '3.2 Engine capacity data.

Fuel oil (Marine diesel oil / marine gas oil or heavy fuel oil)

- ✓ Pre-circulation is required
- ✓ Engine inlet viscosity : 12 ~ 18 cSt (Heavy fuel oil)
2 ~ 14 cSt (Marine diesel oil / marine gas oil)

Emergency cold starting condition

Fuel oil : only marine diesel oil / marine gas oil is acceptable.

Cooling water : minimum 5 °C

Lubricating oil : minimum 10 °C, pre-lubricated
(Approx.1500 cSt based on SAE 40)

Intake air temperature : minimum 0 °C

5.1.3 Engine start

Engine start ready

Engine start ready condition is indicated in local and remote. It is recommended that engine is to be in warm condition before start.

Starter

- ✓ An air motor is installed in engine side and drives fly wheel through gears.
- ✓ The air motor is operated by compressed air and controlled by pneumatic solenoid valve. (See '9.1 Internal compressed air system')

Start block signals

- ✓ Turning gear engaged
- ✓ 'Blocking' switch 'ON'
- ✓ Stop signal 'activated'
- ✓ Common shutdown
- ✓ Lubricating oil pressure at engine inlet low
- ✓ Tacho failure

5.1.4 Restriction for low load operation

Idle running

- ✓ Less than 5 minutes of idle running is permitted if the engine is going to stop.
- ✓ Maximum 30 minutes of idle running is permitted if the engine is loaded after idle running.

Long term low load operation

Marine diesel oil and marine gas oil operation

- ✓ Over 15 % load operation : no restriction
- ✓ Below 15 % load operation : load up over 70 % load at every limited time at corresponding load in Figure 5.1.

Heavy fuel oil operation

- ✓ Over 20 % load operation : no restriction
- ✓ Below 20 % load operation : load up over 70 % load at every limited time at corresponding load in Figure 5.1.

Duration of flushing operation (See Figure 5.1)

'Time limits for low load operation' (left) shows admissible operation time at certain load, and 'Duration of flushing operation' (right) shows. The required time for duration that engine operates at not less than 70 % of full load in order for burning the deposits away.

Example

1. Time limits for low load operation (line A, A')
 At 10 % of full load, heavy fuel oil operation is permissible for about 17 hours (line A), whereas marine diesel oil/marine gas oil operation for 37 hours. (line A').
2. Duration of flushing operation (line B, B')
 Engine should be operated for roughly 1.15 hours (heavy fuel oil) and 0.75 hours (marine diesel oil / marine gas oil) at not less than 70 % of full load.

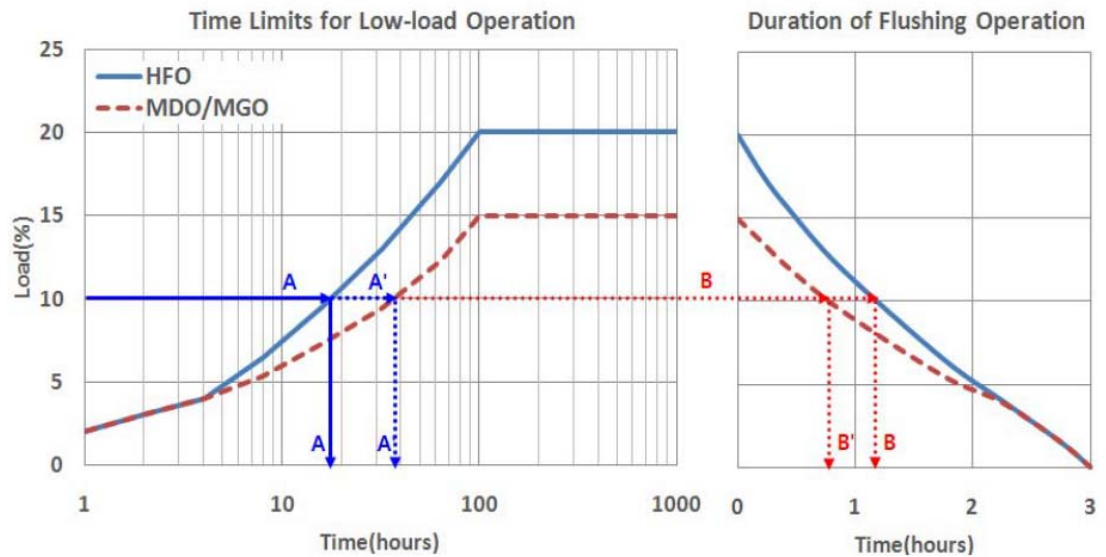

Figure 5.1 Time limits for low load operation

5.1.5 Engine load-up

HiMSEN engines fulfill all requirements regarding the load application of all major classification societies and IACS.

The engine has to be in warm condition for normal or emergency load up. When the engine is in cold condition, the continuous load up should be slower than normal and high step load should be prohibited.

Continuous load-up

The continuous load up capacity in engine condition is referred in Figure 5.2.

At warm condition, the 100 % load can be achieved in 2 min. by continuous ramping up at normal condition. At emergency condition, the load can be more quickly increased to 100 % in 30 sec.

Step by step load-up

Considering the time and safety required for stabilizing the frequency due to sudden load up, it is recommended to load up from idle to full load by more than three steps under approval of classification society. HiMSEN generating-sets fulfill the requirements of classification societies concerning the frequency deviation and recovery time when loading up 3 steps from 0 % to 100 %.

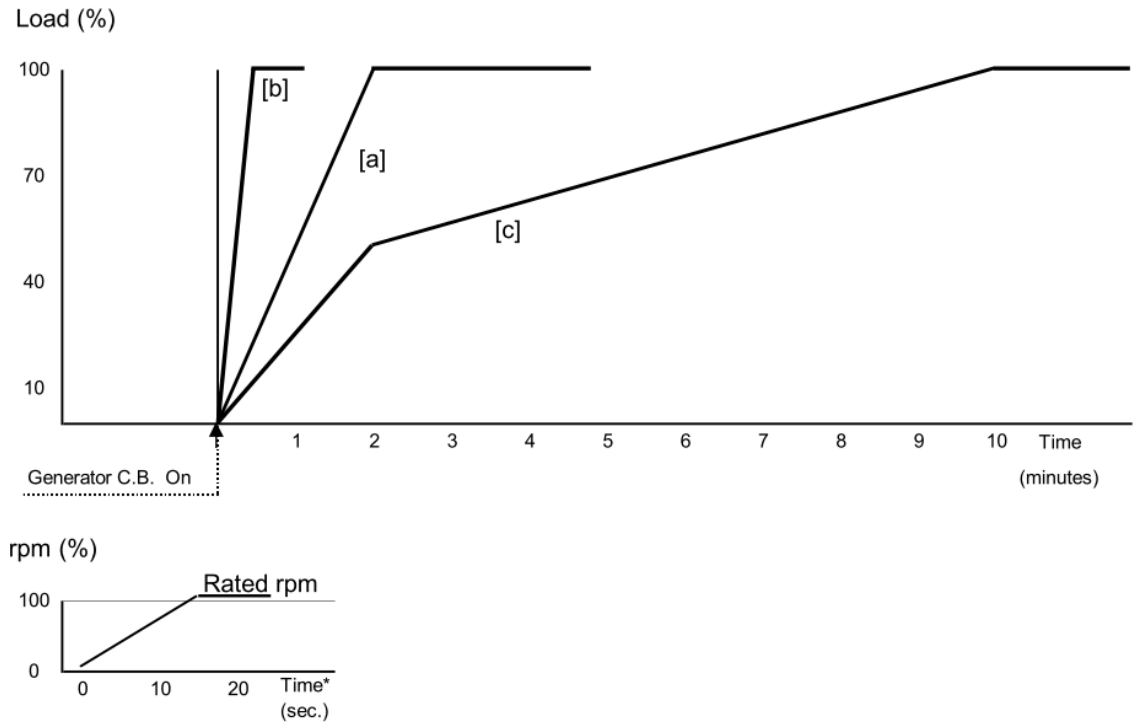

* The starting time may be subject to change and shall be informed separately for specific project.

Figure 5.2 Engine load up capacity in ramp

Curve [a] : Starting condition and load-up with warm(stand by) engine

- ✓ Continuous pre-lubricating is required
- ✓ Lubricating oil temperature : over 40 °C
- ✓ Jacket cooling water temperature : over 40 °C on marine diesel oil start
- ✓ Jacket cooling water temperature : over 60 °C on heavy fuel oil start
- ✓ Intake air(Compressor air inlet) temperature : between 0 °C and 45 °C
- ✓ Starting air pressure : refer to the sheet '3.2 Engine capacity data'.
- ✓ Fuel oil : marine diesel oil or heavy fuel oil

Curve [b] : Maximum capacity for quick starting and load-up with warm(stand by) engine

- ✓ Required same condition as curve [a]

Curve [c] : Stating condition and load-up with cold engine

- ✓ Continuous pre-lubricating is required
- ✓ Lubricating oil temperature : minimum 10 °C
- ✓ Jacket cooling water temperature : minimum 15 °C
- ✓ Intake air(Compressor air inlet) temperature : minimum 0 °C
- ✓ Starting air pressure : starting condition with warm engine + minimum 5 bar
- ✓ Fuel oil : only marine diesel oil acceptable

5.1.6 Engine stop

Two stop functions are applied to engine for safety reason.

Emergency stop

Emergency stop valve activates stop air cylinder at each fuel injection pump and governor stops the engine via fuel regulating shaft by stop solenoid valve simultaneously.

Normal stop

Governor stops the engine via fuel regulating shaft.

Stop signals

Both stoppers are activated by normal stop order by stop button or shut-down signals as below;

- ✓ Lubricating oil pressure switch 'Low'
- ✓ High temperature cooling water temperature switch 'High'
- ✓ Engine over speed rpm 'High'
- ✓ Emergency stop switch 'Operation'
- ✓ Bearing temperature switch 'High' (Option)
- ✓ Oil mist density 'High' (Option)
- ✓ Both engine speed sensors 'Fail'

5.1.7 Prelubrication system**Prelubricating oil pump**

The pump unit is installed in engine side and supplies prelubricating oil to engine during either the engine stops or the engine's rpm level is below run state during engine starting.

5.2 Outline of engine automation

5.2.1 General

HiMSEN generating-sets provide automation system for engine safety, control and indicating based on programmable logic controller.

The system is independently installed in each engine and also can be connected to the remote system, for example main switch board of engine control room via hard wired communication cables.

In addition to fulfilling the requirements of all classification societies and IACS, the system provides more friendly features to customers.

For example,

- ✓ Compact size and easy installation
- ✓ Digital display (Engine and Turbocharger rpm)

5.2.2 System configuration

The system consists of the following sub systems.

Refer to Figure 5.3 for concept of sub system.

- ✓ Control (Start / Stop) and safety system
- ✓ Digital tachometer unit (Engine and turbocharger rpm)
- ✓ Indicating and switch unit
- ✓ Electronic instrumentation
- ✓ Local gauges
- ✓ Provision for external signal interface of yard's requirement

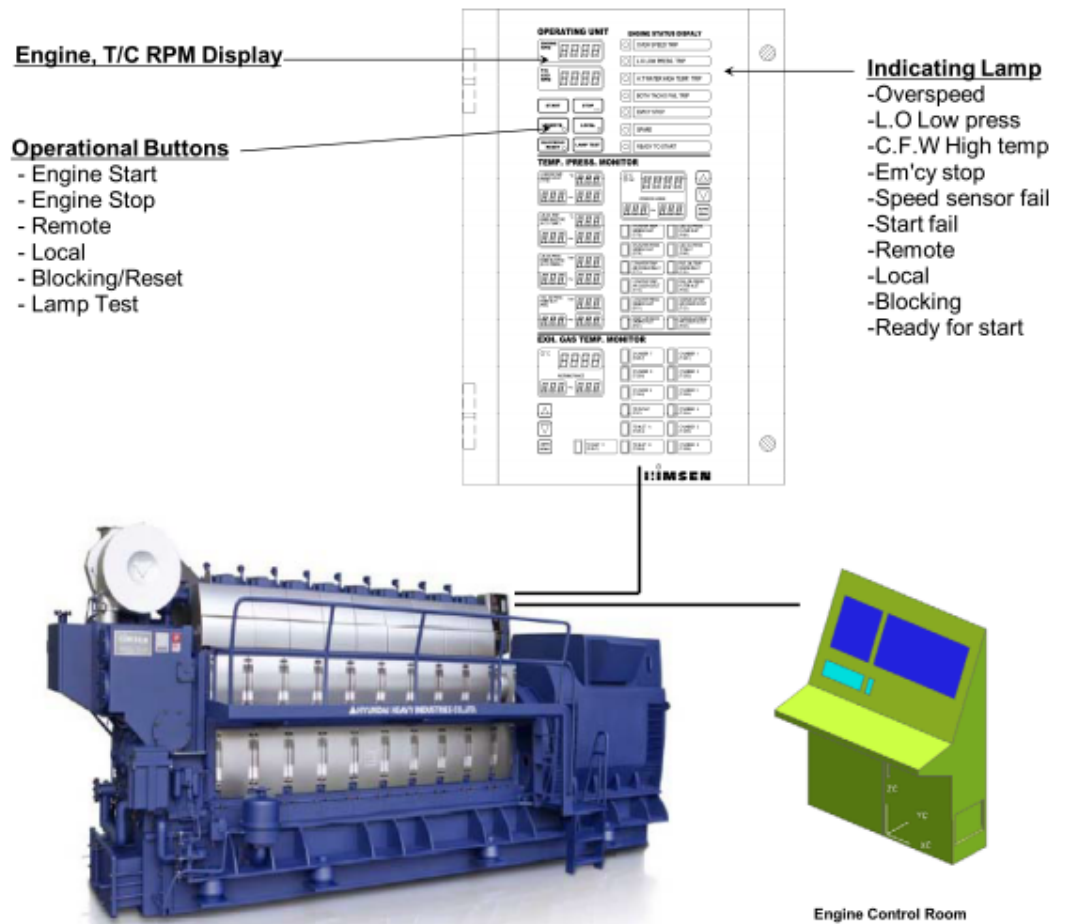

Reference diagram. The detail specification shall be decided at contract

Figure 5.3 HiMSEN engine control communication interface

5.3 Operation data and alarm points

Operation data of the engine is listed below table.
Some data may be subject to change and shall be informed separately for specific project.

Table 5.1 Operation data of the engine

System	Descriptions	Normal operation range at rated power		Alarm and sensor		Autostop of engine	
Speed control	Engine speed	SI47	900 rpm 1000 rpm			SD High	113%(1 st) 115%(2 nd)
	T/C speed	SI42		AL High	(A)		Rated of speed
Fuel oil system	Fuel oil filter differential pressure	PI51 ~ 52	0.1~1.0 bar	AL High	1.5 bar		
	Fuel oil pressure engine inlet	PI51					
	For continuous HFO operation	(MDO)	4.0 ~ 8.0 bar	AL Low*	1 bar		
		(HFO)	7.0 ~ 10.0 bar	AL Low*	6 bar		
	For continuous MDO operation	(MDO)	7.0 ~ 8.0 bar	AL Low*	6 bar		
	Fuel oil temperature engine inlet	TI51					
		(MDO)	30 ~ 45 °C				
(HFO)		110 ~ 150°C	AL High*	155 °C			
Clean fuel oil leakage tank level	LS54		AL High	High level			
Lubricating oil system	Lubricating oil filter differential pressure (D)	PI61 ~ 62	0.1 ~ 1.0 bar	AL High	1.5 bar	SD Low	3 bar
	Lubricating oil pressure engine inlet	PI62	4.0 ~ 5.0 bar	AL Low	3.5 bar		
	Lubricating oil priming pressure			AL Low	0.08 bar		
	Lubricating oil temperature engine inlet	TI62	60 ~ 70 °C	AL High	80 °C		
	Lubricating oil pressure T/C inlet	PI63	(A)	AL Low*	(A)		
	Lubricating oil temperature main bearing*)	TI69		AL High	95 °C	SD High	100 °C
	Lubricating oil mist detector*)			AL High	High level	SD High	High level
	Lubricating oil sump tank level			AL High	High level		
			AL Low	Low level			

System	Descriptions	Normal operation range at rated power		Alarm and sensor		Autostop of engine	
Cooling water system	High temperature water pressure engine inlet	PI75	2.5 ~ 5.0 bar	AL Low*)	0.4+(B) bar		
	High temperature water temperature engine inlet	TI75	70 ~ 80 °C				
	High temperature water temperature engine outlet	TI76	75 ~ 85 °C	AL High	90 °C	SD High	95 °C
	Low temperature water pressure engine inlet	PT71	1.0 ~ 5.0 bar	AL Low*)	0.4+(B) bar		
	Low temperature water temperature engine inlet	TI71	30 ~ 40 °C	AL High*)	45 °C		
	Low temperature water temperature air cooler outlet	TI72	35 ~ 50 °C				
Combustion gas / air system	Cylinder pressure(C)		Max. 160 bar (6H17/28E) Max. 200 bar (6H17/28U)				
	Cylinder pressure deviation from average of cylinders		Max. ±5 bar				
	Charge air pressure after cooler	PI21	2.8 ~ 3.8 bar				
	Charge air temperature after cooler	TI21	35 ~ 58 °C				
	Exhaust gas temperature deviation from average of cylinders	TI25	±50 °C	AL High	±70 °C		
	Exhaust gas temperature T/C inlet	TI26	420 ~ 580 °C	AL High	620 °C		
	Exhaust gas temperature T/C outlet	TI27)	250 ~ 390 °C	AL High*)	430 °C		
Compressed air system	Compressed air inlet pressure (After reducing valve)	PI41	8 ~ 10 bar	AL Low	7.5 bar		

(A). Depending on cylinder No. and T/C maker

(B). Depend on the height of expansion tank

(C). Measured at indicator cock

(D) Based on standard cartridge type filter.

*) Can be applied as an option.

Table 5.2 Definition of code

Code	Description	Code	Description
AL	Alarm	SD	Shutdown

Table 5.3 Operation data for each T/C maker

T/C maker	T/C type	T/C lubricating inlet pressure	
		Pressure range	Alarm
		Bar	Bar
KBB	ST - series	2.0 ~ 4.0	1.5
ABB	TPS - series	2.0 ~ 3.0	1.5
	A130 ~ A145	3.2 ~ 4.5	3.0
	A150 ~ A155	1.5 ~ 2.5	1.3
	TPL - series	1.5 ~ 2.5	1.3
MHI	MET30SRC	0.6 ~ 1.5	0.6
	MET37SRC	0.6 ~ 1.5	0.6
Napier	Na - series	1.5 ~ 2.5	1.3

Table 5.4 The symbol number and measuring range for local instrument

	Description	Symbol No.	Measuring range
Pressure	Fuel oil pressure at engine inlet	PI 52	0 ~ 16 bar
	Lubricating oil pressure at engine inlet	PI 62	0 ~ 10 bar
Temperature	Fuel oil temperature at engine inlet	TI 52	0 ~ 200 °C
	Low temperature water temperature at air cooler inlet	TI 71	0 ~ 120 °C
	Low temperature water temperature at air cooler outlet	TI 72	0 ~ 120 °C

1. All measurement can be monitored on local operating panel.

5.4 Hyundai intelligent Equipment Management Solution (HiEMS)

Introduction

HiEMS, offers a real-time engine status monitoring, troubleshooting guidance to marine engineers and provides connectivity between engines and on shore monitoring center.

With HiEMS, HiMSEN customers can get our experts of engine and service close to you.

With intuitive UI, engine operators can figure out the root cause of a certain alarm and get the technical advice and troubleshooting guide. When detecting the abnormalities in engine, HiEMS transfers alarm/fault information and sensor data to onshore for the detail analysis.

Also, HiEMS keeps long term data for fleet and engine managements.

Benefits

On Ship

HiEMS provides guidance for the engine operator, maintenance function with engineering based instruction guide and integrated trouble shooting guide, which enables engine operators to run and maintain HiMSEN Engine at optimal condition.

On Shore

Ship managers can manage the fleet of HiMSEN engines with HiEMS, accessible 24*7 through the Digital Innovation (DI) center of HGS (Hyundai Global Service).

Ship managers can get real-time remote diagnostics, qualified advices and services from our engineers and service experts. (On reporting service version)

Main features

On Ship

Real-time status monitoring of the HiMSEN engine

- ✓ Status of the engine, indicator of sub systems, trend and surveillance with FAT.

Analysis tools for engine data

- ✓ Performance, deviation, correlation analysis and statistics.

Maintenance and guidance based on the instruction guide

- ✓ Alarm manager, maintenance manager, wearing parts manager.

On Shore

Status monitoring of the fleet of HiMSEN engines

- ✓ Overall status of alarm and running hour.
- ✓ Long term data management and reporting service.

License policy

Standard version

All main features for “On ship” is available, data of a specific time interval is sent to on shore, such as alarm, statistics and operational data.

Reporting service version

Including “Standard version” features, regular reporting service is available through Hyundai Global Service (HGS).

Contact Hyundai Global Service (HGS) for reporting service.

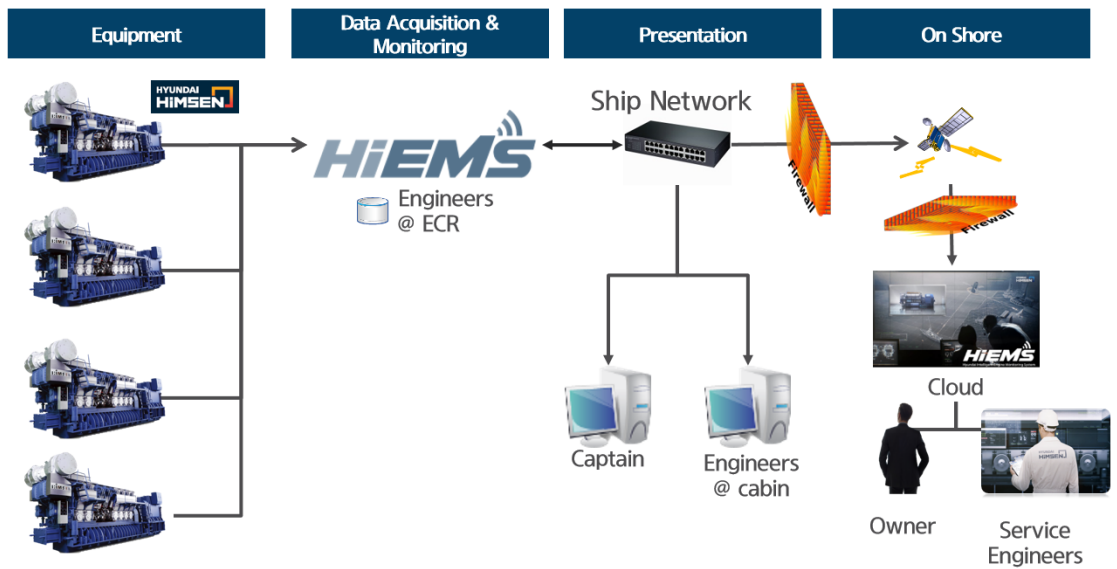

Figure 5.4 HiMEMS configuration and network

Key functions

Real-time status monitoring of the HiMSEN engine

- ✓ Indicators of sub systems, running information.
- ✓ Status information by location through P&ID. (DF only)

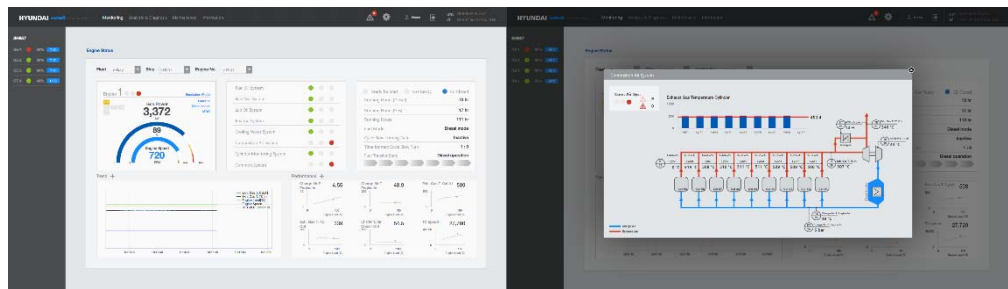

Figure 5.5 display of real-time status monitoring

Maintenance

Maintenance and guidance based on the instruction guide

- ✓ Alarm/Event, maintenance, wearing parts manager.

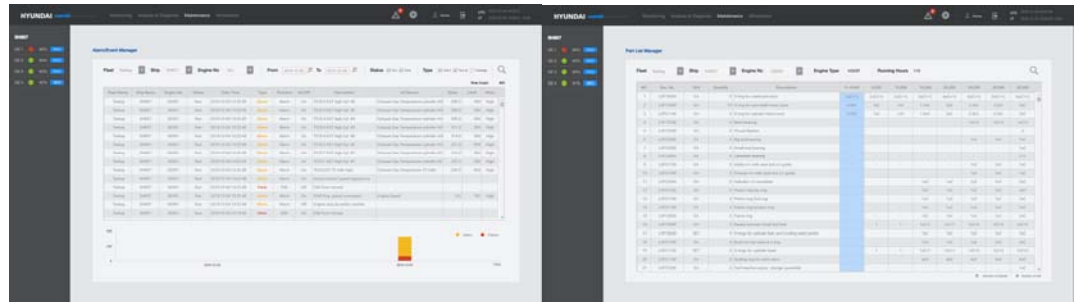

Figure 5.6 Display for the maintenance and guide

Analysis and diagnosis

Analysis tools for engine data

- ✓ Performance, deviation, correlation analysis and statistics.
- ✓ Compare FAT data with current state.

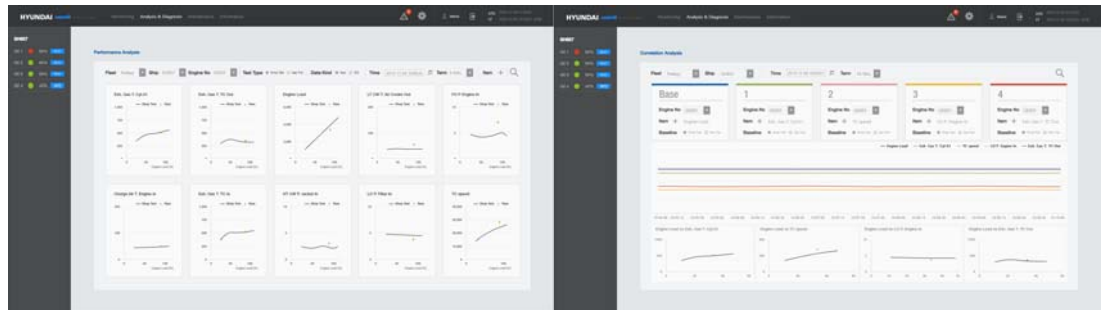

Figure 5.7 Display for the engine analysis

Fleet management (Option)

On shore, status monitoring of the fleet of HiMSEN engines

- ✓ Overall status of alarm, running hour and reporting service.



Figure 5.8 Digital innovation center

This page is intentionally blanked

6 Fuel system

6.1 Internal fuel oil system

Diagram for Internal fuel oil system

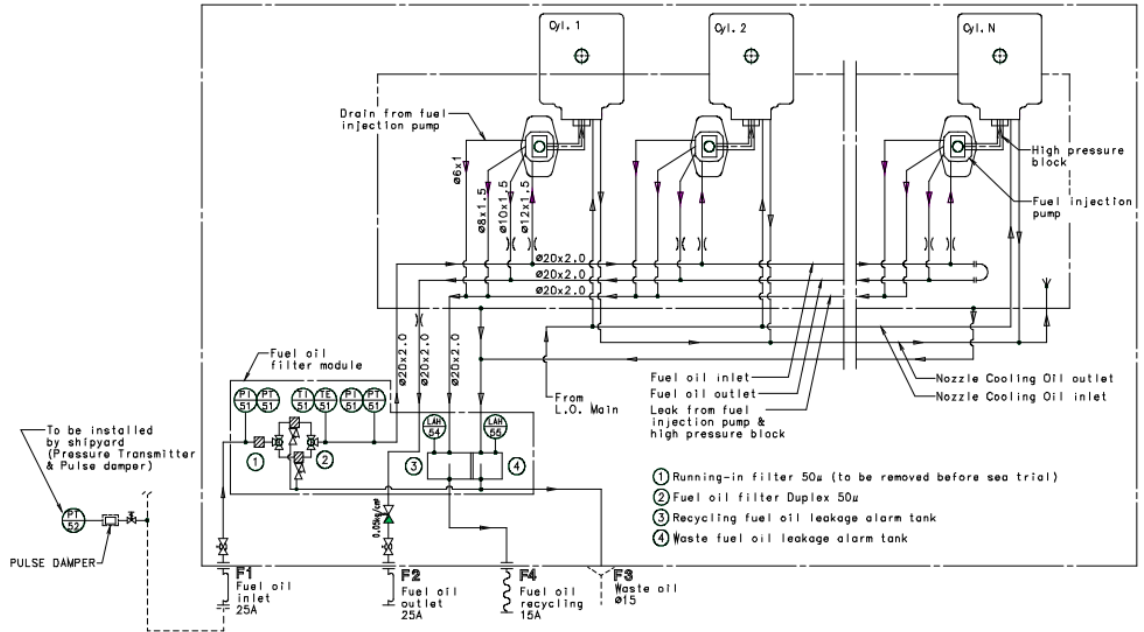

*) Scope of instrumentations will be according to extent of delivery and engine builder's standard.

Figure 6.1 Diagram for Internal fuel oil system

Table 6.1 Size of external pipe connections

Code	Description	Size	Remark
F1	Fuel oil inlet	25A	JIS B 2220
F2	Fuel oil outlet	25A	JIS B 2220
F3	Leaked fuel oil drain (dirty oil)	Ø 15	JIS B 2220
F4	Recycling fuel oil drain (clean oil)	15A	JIS B 2220

6.1.1 General description

Fuel system for the diesel engine is designed for a reliable combustion of heavy fuel oil as well as diesel fuel oil. Therefore, it is not recommended to change over the fuels except for the cold starting, flushing of the system, maintenance or long term stand still.

Fuel oil system

The fuel oil injection equipment comprises an injection pump, injection pipe and injection valve, which are installed on each cylinder. The system is designed for operating the high pressure of the fuel injection with better combustion.

The amount of fuel injection is controlled by governor via the common regulating shaft and spring loaded linkage, which maintains the engine speed at the preset-value by continuous positioning of the fuel pump rack.

The clean leak oil from each injection pump, high pressure connection block, etc. is drained and collected to the recycling fuel oil leakage alarm tank. It can be recycled without additional separation process. Recycling fuel oil leakage alarm tank is a modularized box for the external connections, which provides :

- ✓ Connections for fuel oil return pipes 25A
- ✓ Connection for a recycling drain pipe 15A
- ✓ Alarm switch and tank for excessive leakage

The dirty leak oil is collected to the common drain pipe led to the sludge tank.
The total leak rate of fuel oil is $0.20 \times C_f^{1)}$ liter / cylinder hour (Tolerance $\pm 50 \%$). The recycling fuel oil can be led to external tank to be reused.

- 1) C_f : Heavy fuel oil = 0.5, Marine diesel oil = 1.0, Marine gas oil = 2.0

6.2 External fuel oil system

Diagram for heavy fuel oil system – Normal operation

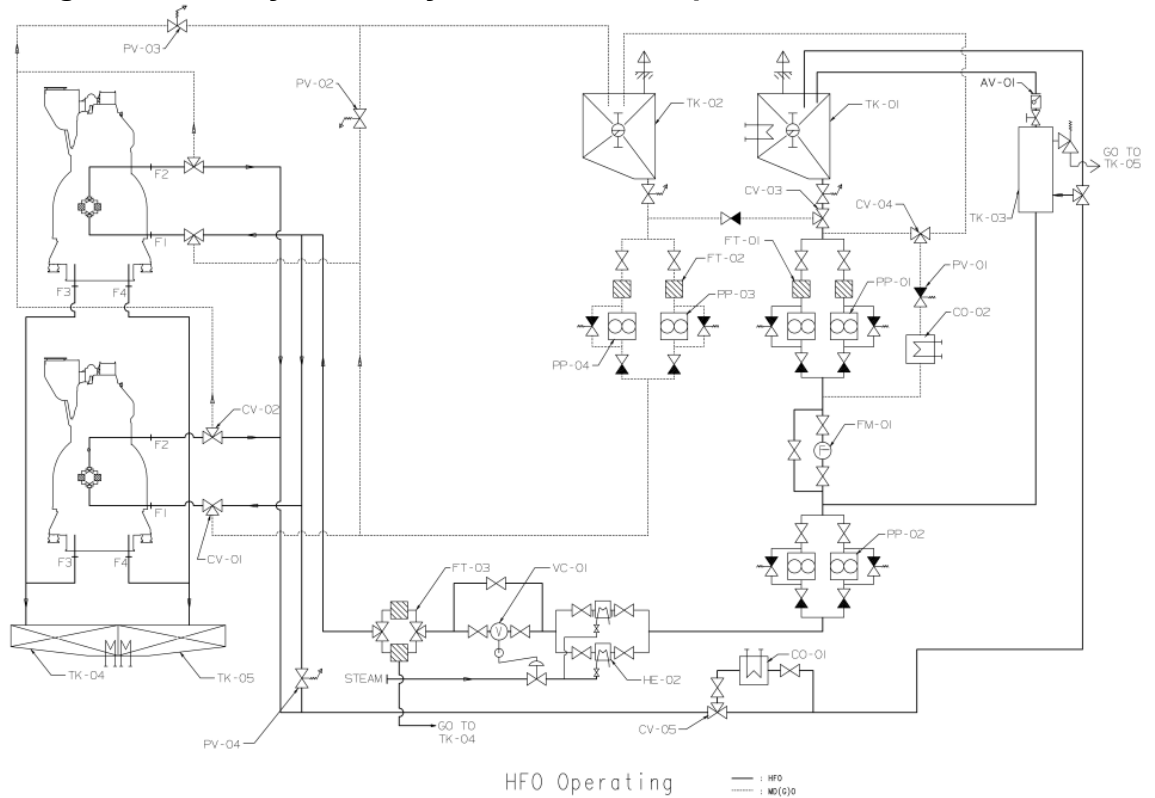

Figure 6.2 Diagram for heavy fuel oil system (B91-328883-6.0)

Table 6.2 System components

Code	Description	Code	Description
TK-01	Day tank, heavy fuel oil	FT-01	Suction strainer, heavy fuel oil
TK-02	Day tank, marine diesel oil	FT-02	Suction strainer, marine diesel oil
TK-03	Mixing tank	FT-03	Automatic filter
TK-04	Drain tank for dirty oil	CO-01	Marine diesel oil cooler
TK-05	Drain tank for clean oil	CO-02	Cooler
AV-01	Auto deaerating valve	HE-02	Heater
FM-01	Flow meter	VC-01	Viscosity controller
PP-01	Heavy fuel oil supply pump (4 bar)	PV-01	Pressure control valve

Code	Description	Code	Description
PP-02	Heavy fuel oil booster pump (8 bar at fuel oil inlet, F1)	PV-02	Marine diesel oil inlet pressure control valve (6 bar)
PP-03/04	Emergency marine diesel oil pump (6 bar)	PV-03	Marine diesel oil outlet pressure control valve (2 bar)
CV-01~05	Heavy fuel oil, marine diesel oil change over valve	PV-04	Heavy fuel oil inlet pressure control valve (9 bar)

1. In case of continuous marine diesel oil operation, contact to HHI-EMD.
2. Additional day tanks for low sulfur heavy fuel oil and / or marine diesel oil could be required due to IMO MARPOL Annex VI, a special notation of classification societies, a local regulation, or other reasons.
3. This heavy fuel oil system is only for guidance for generator engines. All external piping design and system arrangement should be designed by shipbuilder in accordance to the classification rules and building specifications.

Diagram for marine diesel oil (marine gas oil) system – Normal operation

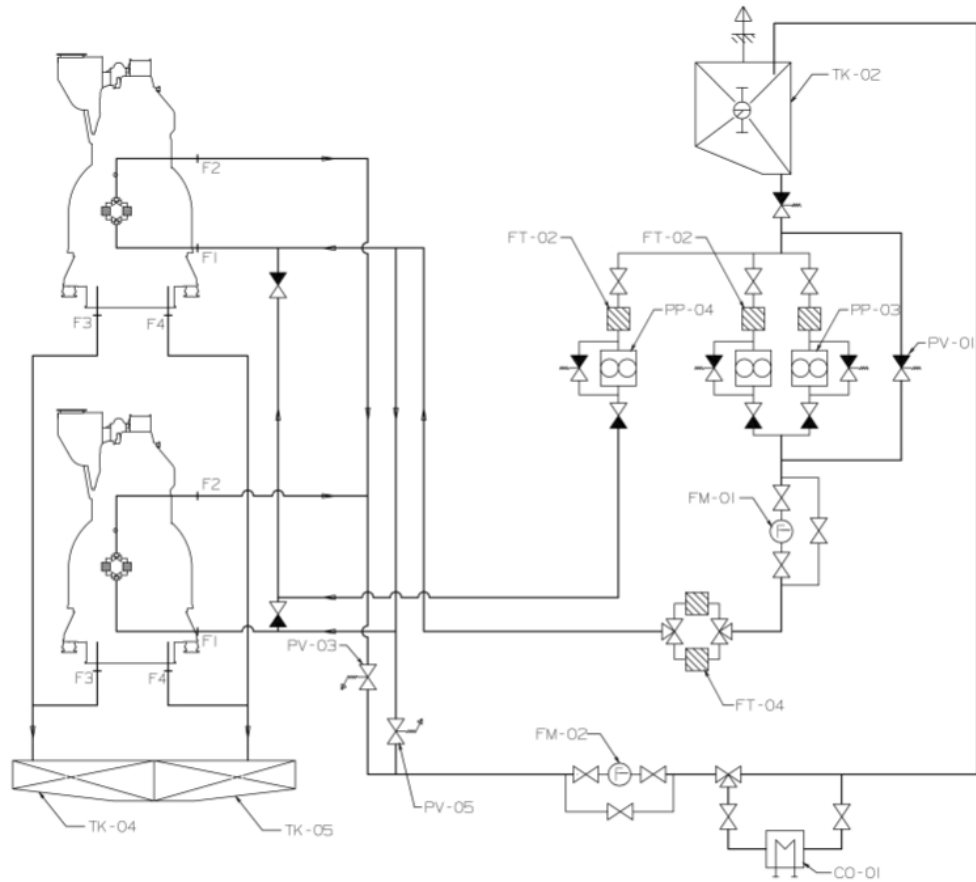

Figure 6.3 Diagram for marine diesel oil (marine gas oil) system (B91-328883-6.1)

Table 6.3 System components

Code	Description	Code	Description
TK-02	Day tank, marine diesel oil	FT-02	Suction strainer, marine diesel oil
TK-04	Drain tank	FT-04	Duplex filter
TK-05	Drain tank for clean oil	CO-01	Marine diesel oil cooler
FM-01	Flow meter	PP-03/04	Emergency marine diesel oil pump (6 bar)
PV-01	Pressure control valve	PV-03	Marine diesel oil outlet pressure control valve (2 bar)
FM-02	Flow meter		

1. In case of continuous marine diesel oil operation, contact to HHI-EMD.
2. Additional day tanks for low sulfur heavy fuel oil and / or marine diesel oil could be required due to IMO MARPOL Annex VI, a special notation of classification societies, a local regulation, or other reasons.
3. This heavy fuel oil system is only for guidance for generator engines. All external piping design and system arrangement should be designed by shipbuilder in accordance to the classification rules and building specifications

6.2.1 General requirements

The external fuel system for the auxiliary engines can be a common with main engine system or an independent system depending on the shipbuilder's choice.

In any cases, the condition of fuel oil, especially heavy fuel oil, is critical for the reliable operation of the engine. The most important conditions and requirements of the external fuel oil system are described as follows :

Well cleaned fuel

Solid particles and water in the fuel cause over wearing and frequent maintenance for the engine itself as well as external fuel system. Therefore, the proper and reliable separation equipment should be included in the external fuel oil system not only for heavy fuel oil but also for distillate fuel.

Proper viscosity, temperature, pressure

The appropriate viscosity, temperature and pressure are necessary. Therefore, preheating, insulation with heat tracing, and pressurizing equipment should be included in the external fuel oil system. Especially if the fuel is at low viscosity, fuel temperature should be controlled to meet the required viscosity by fuel cooling device such as cooler unit.

In order to prevent excessive pressure losses and also to minimize possible pressure pulses in the piping system, the fuel oil velocity should not exceed :

- ✓ Marine diesel oil suction pipe : 0.5 ~ 1.0 m/s
- ✓ Marine diesel oil pressure pipe : 1.5 ~ 2.0 m/s
- ✓ Heavy fuel oil suction pipe : 0.3 ~ 0.8 m/s
- ✓ Heavy fuel oil pressure pipe : 0.5 ~ 1.2 m/s

Marine diesel fuel oil

Diesel fuel oil system is necessary to back up (especially for emergency situations) and, it is also used for flushing before engine stop for long period standstill and in the event of major overhaul.

External fuel oil system

Normally the external fuel system comprises the fuel treatment system and fuel feed system. General requirements described on next section and more detailed information can be provided if needed for specific vessel or plant.

Fuel oil treatment system

The fuel treatment system should be designed for proper cleaning of heavy fuel oil considering total fuel consumption of the vessel. Centrifugal separators should be an automatic type with the same additional stand-by unit. The separator should be capable of purifying the worst grade of the fuel oil. Normally, the fuel oil grade of H380 to H700 requires the capability of up to 1010 kg/m³.

For distillate fuel, an independent purifier system is required.

It is necessary to ensure a proper cleaning of heavy fuel oil as follows :

- ✓ Selection and operation of fuel oil centrifuges according to supplier's recommendation
- ✓ Correct heavy fuel oil temperature at inlet to centrifuges
(The centrifuges should be always operated with an inlet temperature of 98 °C for heavy fuel oil)
- ✓ Correct throughput of fuel oil through centrifuges

$$Q = \frac{P \times b \times 24(h)}{\rho \times t}$$

P = maximum continuous output of the engine(s) [kW]

b = specific fuel consumption + safety margin (15 %) [g/kWh]

ρ = density of the fuel [kg/m³]

t = daily separating time(h) (usually = 23 h or 23.5 h)

- ✓ Proper density of heavy fuel oil in conformance with centrifuge specification
- ✓ Proper maintenance of centrifuges

The centrifuges should be operated in parallel, unless the centrifuge installation comprises manually operated centrifuges, with the purifier followed by the clarifier. To achieve the maximum separation efficiency, it is recommended to always use all available heavy fuel oil centrifuges whenever possible, and to operate them in parallel with an adjusted feed rate lowering the throughput in the centrifuges. This will ensure the longest possible retention time in the centrifuges and optimal efficiency for removal of catalytic fines.

It is important that maintenance and operation of the centrifuge is done according to the recommendations of the manufacturer.

The required capacity of the daily (service) tank and the settling tank for heavy fuel oil is minimum 24 operating hours feed for continuous full load operation. Each tank should be heated to have stable temperature between 50 ~ 70 °C. Each tank should be equipped with effective sludge and water drain system.

6.2.2 Fuel feed system

The fuel feed system can be common with other engines. The one of the most important is the proper control of the fuel viscosity. So the fuel feed system should have appropriated heating equipment and insulation accordingly. In addition, the fuel oil should be pressurized to avoid the gas separation due to high temperature.

Day tank for heavy fuel oil

The heavy fuel day tank should be filled with cleaned fuel by continuous fuel separation.

- ✓ Tank capacity : minimum 24 operating hours feed for full load operation.
- ✓ Tank heating : approx. 75 °C, as stable as possible.
- ✓ Sludge / water space and drain provided.

Heavy fuel oil / marine diesel oil changeover valve

The heavy fuel oil and marine diesel oil changeover valves should be installed before the supply pump and the cooler for fuel oil outlet respectively. The valve can be a manual type or an electro-pneumatic remote control type for the flexible fuel mode selection at any load conditions.

Suction strainer

To protect the supply pump, a suction strainer with a fineness of approx. 0.5 mm with magnet should be installed on the pump suction side.

Supply pump

- ✓ Capacity : min. 1.5 x total fuel consumption at maximum continuous rating + back flushing quantity
- ✓ Pump head : 4 bar
- ✓ Operating temperature : 100 °C
- ✓ Viscosity (for electric motor) : 1000 cSt

Flow meter

If a measuring device for fuel oil consumption is required, it has to be fitted between the supply pump and the mixing tank.

A by-pass line has to be installed in parallel with the flow meter to ensure the fuel oil supply free from possible clogging.

Mixing tank

The major purpose of mixing tank is to ensure the ventilation of the gas from the hot fuel oil and a gradual temperature balance by mixing the hot returned oil from the engine with the oil from the day tank.

The volume of mixing is tank is required not less than 100 liters.

Pressure control valve

The pressure control valves maintain constant system pressure. The surplus oil return to the supply pump suction side or to the fuel oil return line.

- ✓ Pressure setting : 4 bar

Booster pump

Since the heated fuel oil has to be continuously recirculated, the booster pump should ensure the fuel circulation with the required pressure in the system.

- ✓ Capacity : min. 3.0 x total fuel consumption at maximum continuous rating + back flushing quantity

- ✓ Pump head : 8 bar at Fuel oil inlet, F1
- ✓ Operating temperature : 150 °C
- ✓ Viscosity (for electric motor) : 500 cSt

Heater and viscosity controller

In order to ensure the correct injection viscosity at 12 ~ 18 cSt (HFO), the dual heaters are controlled by the viscosity controller.

Each heater should have sufficient capacity for heating the fuel oil for all engines at full load, one heater can therefore be overhauled while the other one is in service.

Auto back flushing filter

In the circulating lines, absolute 10 µm automatic back-flushing filter must be installed before the branch pipe for each engine to ensure the cleanness of the fuel oil. If the cleaning cycles of the automatic back-flushing filter are increased, the fuel oil treatment system must be optimized in order to protect the engine.

Safety filter

Fuel oil safety filter, duplex type of absolute 50 µm, to be built in the fuel oil supply line of each engine.

Drain tank for dirty oil

The dirty leak oil from the engine is drained by gravity and collected to the drain tank for dirty oil, where heating coils are required. The drain tank should be transferred to the sludge tank.

Marine diesel oil feed system

Even for the heavy fuel oil engine, an independent marine diesel oil feed system is required for the cases as below;

- ✓ Long time low load operation or stop
- ✓ Maintenance of heavy fuel oil system
- ✓ Emergency situation such as a black-out.

Emergency start

In emergency situation such as black out, marine diesel oil must be supplied to start up stand-by engines with a sufficient fuel oil pressure, which can be supplied by emergency booster pump or a gravity tank which is located minimum 8 m above the engine.

6.3 Fuel oil specification

The fuel oil specifications are based on ISO 8217 : 2017. The fuel is largely classified into two categories as distillate fuel and residual fuel. Distillate fuels are categorized into DMX, DMA, DFA, DMZ, DFZ, DMB, and DFB. Residual fuels are categorized into RMA 10, RMB 30, RMD 80, RME 180, RMG 180 to 700, RMK 380 to 700. The usage of DMX is restricted by SOLAS requirement due to its low flash point.

The terminologies of marine fuel oil to be called after 1st January 2020 have been determined as below Table 6.4. In accordance with the most relevant characteristics.

HiMSEN is able to operate with all fuels specified in the below table. The simplified terminologies listed in Table 6.4 allows easy determination if the fuel can be applicable for HiMSEN.

Table 6.4 Designation of fuel grades

Fuel grade		Sulfur content (%)	Typical viscosity (cSt) (at 50 °C for residual fuels and 40 °C for distillate fuels)		ISO 8217 : 2017
			Minimum	Maximum	
HFO (Heavy fuel oil)	HSFO (High sulfur fuel oil)	$1.0 < S \leq 3.5$ (or even higher)	10	700	Residual marine fuels (RMB, RMD, RME, RMG, RMK)
	LSFO (Low sulfur fuel oil)	$0.5 < S \leq 1.0$			
	VLSFO (Very low sulfur fuel oil)	$0.1 < S \leq 0.5$	2 ~ 380 (Not decided yet)		Not defined
	ULSFO (Ultra low sulfur fuel oil)	$S \leq 0.1$	9 ~ 67 (Not decided yet)		
MGO (Marine gas oil)		$S \leq 1.0$	2	6	Distilled marine fuels (DMA, DFA, DMZ, DFZ)
MDO (Marine diesel oil)		$S \leq 1.5$	2	11	Distillate marine fuels (DMB, DFB) Residual marine fuels (RMA 10)

Table 6.5 Specifications of distillate fuels

Characteristics	Unit	Limit	Category ISO-F-							Test method reference
			DMX	DMA	DFA	DMZ	DFZ	DMB	DFB	
Kinematic viscosity at 40 °C	mm ² /s ^{a)}	max.	5.5	6.0		6.0		11.0		ISO 3104
		min.	1.4	2.0		3.0		2.0		
Density at 15 °C	Kg/m ³	min.	-	890.0		890.0		900.0		ISO 3675 or ISO 12185
Cetane index	-	min.	45	40		40		35		ISO 4264
Sulfur ^{b)}	Mass %	max.	1.0	1.0		1.0		1.5		ISO 8754 ISO 14596 ASTM D4294
Flash point	°C	min.	43.0	60.0		60.0		60.0		ISO 2719
Hydrogen sulfide	mg/kg	max.	2.0	2.0		2.0		2.0		IP 570
Acid number	mg KOH/g	max.	0.5	0.5		0.5		0.5		ASTM D664
Total sediment by hot filtration	Mass %	max.	-	-		-		0.10 ^{c)}		ISO 10307-1
Oxidation stability	g/m ³	max.	25	25		25		25 ^{d)}		ISO12205
Fatty acid methyl ester(FAME) ^{e)}	Volum e %	max.	-	-	7.0	-	7.0	-	7.0	ASTM D7963 or IP579
Carbon residue : micro method on the 10 % volume distillation residue	Mass %	max.	0.3	0.30		0.30		-		ISO 10370
Carbon residue : micro method	Mass %	max.	-	-		-		0.30		ISO 10370
Cloud point ^{f)}	Winter	°C	max.	-16	report		report		-	ISO 3015
	Summer	°C	min.	-16	-		-		-	
Cold filter plugging point ^{f)}	Winter	°C	max.	-	report		report		-	IP 309 or IP 612
	Summer	°C	min.	-	-		-		-	
Pour point (upper) ^{f)}	Winter	°C	max.	-	-6		-6		0	ISO 3016
	Summer	°C	max.	-	0		0		6	
Appearance	-	-	Clear and bright ^{g)}					°)		
Water	Volum e %	max.	-	-		-		0.30 ^{c)}		ISO 3733
Ash	Mass %	max.	0.01	0.01		0.01		0.01		ISO 6245
Lubricity, corrected wear scar diameter (WSD 1,4) at 60 °C ^{h)}	µm	max.	520	520		520		520 ^{d)}		ISO 12156-1

- a) $1 \text{ mm}^2/\text{s} = 1 \text{ cSt}$
- b) Notwithstanding the limits given, a purchaser shall define the maximum sulfur content in accordance with relevant statutory limitations. See introduction of ISO 8217 : 2017.
- c) If the sample is not clear and bright, the total sediment by hot filtration and water tests shall be required. See 6.8 and 6.12 of ISO 8217 : 2017.
- d) If the sample is not clear and bright, the test cannot be undertaken and therefore, compliance with this limit cannot be shown.
- e) See 5.1 and Annex A of ISO 8217 : 2017
- f) Pour point cannot guarantee operability for all ships in all climates. The purchaser should confirm that the cold flow characteristics (pour point, cold filter plugging point) are suitable for the ship's design and intended voyage. See 6.11 of ISO 8217 : 2017.
- g) If the sample is dyed and not transparent, then the water limit and test method as given in 6.12 of ISO 8217 : 2017 shall apply.
- h) This requirement is applicable to fuels with a sulfur content below 500 mg/kg (0.050 mass %).

Table 6.6 Specifications of residual fuels

Characteristics	Unit	Limit	Category ISO-F-				Test method reference	
			RMA	RMB	RMD	RME		
			10	30	80	180		
Kinematic viscosity at 50 °C	mm ² /s ^{a)}	max .	10.0	30.0	80.0	180.0	ISO 3104	
Density at 15 °C	kg/m ³	max .	920.0	960.0	975.0	991.0	ISO 3675 or ISO 12185	
CCAI	-	max .	850	860	860	860		
Sulfur ^{b)}	mass %	max .	Statutory requirements ^{*)}				ISO 8754 ISO 14596 ASTM D4294	
Flash point	°C	min.	60.0	60.0	60.0	60.0	ISO 2719	
Hydrogen sulfide	mg/kg	max .	2.0	2.0	2.0	2.0	IP 570	
Acid number ^{c)}	mg KOH/g	max .	2.5	2.5	2.5	2.5	ASTM D664	
Total sediment aged	mass %	max .	0.1	0.1	0.1	0.1	ISO 10307-2	
Carbon residue : micro method	mass %	max .	2.5	10.0	14.0	15.0	ISO 10370	
Pour point(upper) ^{d)}	Winter	°C	max .	0	0	30	30	ISO 3016
	Summer	°C	max .	6	6	30	30	
Water	volume %	max .	0.30	0.50	0.50	0.50	ISO 3733	
Ash	mass %	max .	0.04	0.07	0.07	0.07	ISO 6245	
Vanadium	mg/kg	max .	50	150	150	150	IP 501, IP 470 or ISO 14597	
Sodium	mg/kg	max .	50	100	100	50	IP 501, IP 470	
Aluminum plus silicon	mg/kg	max .	25	40	40	50	IP 501, IP 470 or ISO 10478	
Used lubricating oils (ULO) Calcium and Zinc ; or calcium and phosphorus	mg/kg	-	Do not use if : calcium > 30 and zinc > 15 or Calcium > 30 and phosphorus > 15				IP 501 or IP 470, IP 500	

a) 1 mm²/s = 1 cSt

b) The purchaser shall define the maximum sulfur content in accordance with relevant statutory limitations.

c) See Annex H of ISO 8217 : 2017.

d) The purchaser should confirm that this pour point is suitable of the ship's intended area of operation.

*) International statutory requirements

This document specifies allowable minimum flash point limits following the provisions given in the SOLAS convention. MARPOL Annex VI, which controls air pollution from ships, includes a requirement that either the fuel shall not exceed a specified maximum sulfur or an approved equivalent alternative means be used. During the lifetime of this document, regional and/or national bodies may introduce their own local emission requirements, which can impact the allowable sulfur content, for example, the EU sulfur directive. It is the purchaser's and the user's responsibility to establish which statutory requirements are to be met and specify on that basis the corresponding maximum fuel sulfur content to the supplier.

Characteristics	Unit	Limit	Category ISO-F-							Test method reference
			RMG				RMK			
			180	380	500	700	380	500	700	
Kinematic viscosity at 50 °C	mm ² /s ^{a)}	max	180.0	380.0	500.0	700.0	380.0	500.0	700.0	ISO 3104
Density at 15 °C	kg/m ³	max	991.0				1,010.0			ISO 3675 or ISO 12185
CCAI	-	max	870				870			
Sulfur ^{b)}	mass %	max	Statutory requirements ^{*)}							ISO 8754 ISO 14596 ASTM D4294
Flash point	°C	min.	60.0				60.0			ISO 2719
Hydrogen sulfide	mg/kg	max	2.0				2.0			IP 570
Acid number ^{c)}	mg KOH/g	max	2.5				2.5			ASTM D664
Total sediment aged	mass %	max	0.1				0.1			ISO 10307-2
Carbon residue : micro method	mass %	max	18.0				20.0			ISO 10370
Pour point(upper) ^{d)}	Winter	°C	30				30			ISO 3016
	Summer	°C	30				30			
Water	volume %	max	0.50				0.50			ISO 3733
Ash	mass %	max	0.10				0.15			ISO 6245
Vanadium	mg/kg	max	350				450			IP 501, IP 470 or ISO 14597
Sodium	mg/kg	max	100				100			IP 501, IP 470
Aluminum plus silicon	mg/kg	max	60				60			IP 501, IP 470 or ISO 10478
Used lubricating oils (ULO) Calcium and Zinc ; or calcium and phosphorus	mg/kg	-	Do not use if : calcium > 30 and zinc > 15 or Calcium > 30 and phosphorus > 15							IP 501 or IP 470, IP 500

a) 1 mm²/s = 1 cSt

b) The purchaser shall define the maximum sulfur content in accordance with relevant statutory limitations.

c) See Annex H of ISO 8217 : 2017.

d) The purchaser should confirm that this pour point is suitable of the ship's intended area of operation.

*) International statutory requirements

This document specifies allowable minimum flash point limits following the provisions given in the SOLAS convention. MARPOL Annex VI, which controls air pollution from ships, includes a requirement that either the fuel shall not exceed a specified maximum sulfur or an approved equivalent alternative means be used. During the lifetime of this document, regional and/or national bodies may introduce their own local emission requirements, which can impact the allowable sulfur content, for example, the EU sulfur directive. It is the purchaser's and the user's responsibility to establish which statutory requirements are to be met and specify on that basis the corresponding maximum fuel sulfur content to the supplier.

Biofuels

Biofuels are largely classified into 3 categories as transesterified biofuels(biodiesel), bio-blends and others. (Classify biofuels with or without International standard)

- ✓ Transesterified Biofuels (International standards EN 14214 or ASTM D 6751-19)
ex) Biodiesel (Fatty Acid Methyl Ester – FAME)
- ✓ HVO (Hydrotreated Vegetable Oil) (International standards EN 15940, Paraffinic Diesel Fuel from Hydrotreatment)
- ✓ Bio-blends (Mixture of Biofuels and Fossil fuels)
- ✓ Other biofuels
ex) Crude biofuels (Palm oils, Vegetable oil, Animal fat), Refined biofuels, etc.

HiMSEN is able to operate continuously with biofuels specified in the below Table 6.7 and Table 6.8

- ✓ When using biofuels included in quality standards Table 6.7 and Table 6.8, you need to get confirmation from HiMSEN.

Biodiesel / Fatty Acid Methyl Ester (FAME)

Biodiesel (FAME) is derived from Crude biofuels by using transesterification processes. It can be used alone or blended with petro-diesel in any proportions.

International standards EN 14214 or ASTM D 6751-19 are commonly used to specify the quality of biodiesel. (See the Table 6.7)

Table 6.7 Specifications of biodiesel(FAME)

Characteristics b)	Unit	Min. limit	Max. limit	Test method reference
FAME content	% (m/m)	96.5	-	EN 14103
Density at 15°C	kg/m ³	860	900	EN ISO 3675 / EN ISO 12185
Viscosity at 40°C	mm ² /s	3.5	5.0	EN ISO 3104 / EN 14105
Cold filter plugging point(CFPP)	°C	-	a)	EN 116
Flash point	°C	101	-	EN ISO 2719 / EN ISO 3679
Sulfur content	mg/kg	-	10	EN ISO 20846 / EN ISO 20884
Cetane number	-	51.0	-	EN ISO 5165
Sulfated ash content	% (m/m)	-	0.02	ISO 3987
Water content	mg/kg	-	500	EN ISO 12937
Total contamination	mg/kg	-	24	EN 12662

Characteristics b)	Unit	Min. limit	Max. limit	Test method reference
Copper strip corrosion (3 hours at 50 °C)	rating	1b(Class1)	1a	EN ISO 2160
Oxidation stability, 110°C	hours	8	-	EN 14112
Total Acid Number (TAN)	mg KOH/g	-	0.5	EN 14104
Iodine value	-	-	120	EN 14111
Linolenic Acid Methylester	% (m/m)	-	12	EN 14103
Polyunsaturated (>= 4 Double bonds) Methylester	% (m/m)	-	1	EN 14103
Methanol content	% (m/m)	-	0.2	EN 14110
Monoglyceride content	% (m/m)	-	0.7	EN 14105
Diglyceride content	% (m/m)	-	0.2	EN 14105
Triglyceride content	% (m/m)	-	0.2	EN 14105
Free Glycerine	% (m/m)	-	0.02	EN 14105 / EN 14106
Total Glycerine	% (m/m)	-	0.25	EN 14105
Group I metals (Na+K)	mg/kg	-	5	EN 14108 / EN 14109 / EN 14538
Group II metals (Ca+Mg)	mg/kg	-	5	EN 14538
Phosphorus content	mg/kg	-	4	EN14107

a) The temperatures related to filterability have to be at least 10~15°C above the minimum fuel oil temperature (maximum temperature among cloud point, pour point, CFPP, and LTFT) in the whole fuel treatment process, even during engine stop unless flushing using pure diesel oil were performed before engine stop.

b) The information of storage and deterioration of Biodiesel regarding EN14214 should be discussed/checked by fuel oil supplier before biodiesel is applied to engine.

Hydrotreated Vegetable Oil (HVO)

The EN 15940:2016 + A1:2018 + AC:2019 standard covers hydrotreated paraffinic renewable diesel fuel and synthetic Fischer-Tropsch products GTL, BTL and Coal-to-Liquid (CTL).

Since HVO consists of paraffinic hydrocarbons, it cannot meet the requirements set by EN 14214:2013+ A2:2019, which is a standard developed and valid only for methyl ester chemistry type biodiesel, namely FAME. As a matter of fact, HVO meets EN 590, except the requirement for minimum density. International standards EN 15940 are commonly used to specify the quality of HVO. (See the Table 6.8)

Table 6.8 Specifications of HVO(EN15940)

Characteristics	Unit	Min. limit	Max. limit	Test method reference
FAME content	% (v/v)	-	7.0	EN 14103
Density at 15°C	kg/m ³	765	800	ISO 3675 / ISO 12185
Total aromatics	% (m/m)	-	1.1	EN 12916
Kinematic viscosity at 40°C	mm ² /s	2.0	4.5	ISO 3104 / EN 14105
Cold filter plugging point(CFPP)	°C	-	a)	EN 116
Flash point	°C	55.0	-	ISO 2719
Sulfur content	mg/kg	-	5	ISO 20846 / ISO 20884
Cetane number	-	70	-	ISO 5165 / EN 15195
Sulfated ash content	% (m/m)	-	0.01	ISO 3987
Water content	% (m/m)	-	0.020	ISO 12937
Total contamination	mg/kg	-	24	EN 12662
Copper strip corrosion (3 hours at 50 °C)	rating	-	Class 1	ISO 2160
Oxidation stability	hours	20	-	EN 14112
Oxidation stability	g/m ³	-	25	EN 14112
Carbon residue : on the 10% volume distillation residue	mass %	-	0.30	ISO 10370
Ash	% (m/m)	-	0.010	ISO 6245
Lubricity HFRR at 60°C	µm	-	460	EN 12156-1
Evaporated at 250°C	% (v/v)	-	65	ISO 3405
Evaporated at 350°C	% (v/v)	-	85	ISO 3405
Distillation 95% (v/v)	°C	-	360.0	ISO 3924

a) The temperatures related to filterability have to be at least 10~15°C above the minimum fuel oil temperature (maximum temperature among cloud point, pour point, CFPP, and LTFT) in the whole fuel treatment process, even during engine stop unless flushing using pure diesel oil were performed before engine stop.

Bio-blends

Bio-blends are mixture of biofuels and fossil fuels.

The volume ratio of the biofuel in the bio-blends are referred to as follows.

- ✓ B##, BD## (## : the volume ratio of the biofuel in the bio-blends)
 - ex) BD20 = Biodiesel 20% + Distillate marine fuels 80%
(In the case of Biodiesel mixture, it is specially referred to as BD##)
 - B20 = Biofuel 20% + Fossil fuel 80%
(Except for Biodiesel mixture, the other bio-blends are referred to as B##)

The quality standards of biodiesel-blends(BD##) are referred to the Table 6.7 and the bio-blends(B##) except for biodiesel-blends(BD##) are referred to the Table 6.9.

General biofuels

The quality standards of general liquid biofuels except biodiesel(FAME) are as shown below Table 6.9.(General biofuels include a wide range of specifications. In order to reduce confusion when applying biofuel standards, HiMSEN set the integrated standard with the Table 6.9.)

Only biofuels that meet EN14214 or EN15940 can be applied to Micro-Pilot (MP) injector. The information of storage and deterioration of biofuels should be discussed/checked by fuel oil supplier before the biofuel is applied to engine.

Table 6.9 Specifications of general biofuel, bio-blends.

Characteristics	Unit	Min. limit	Max. limit	Test method reference
Viscosity before injection pumps	cSt	2	18	ISO 3104
Kinematic viscosity at 50°C	mm ² /s	-	700	
Density at 15°C	kg/m ³	-	1010	ISO 3675 / ISO 12185
Sulfur	mass %	Statutory requirements		ISO 8754 / ISO 14596 / ASTM D4294
Flash point	°C	60	-	ISO 2719
Cloud point	°C	-	a)	ISO 3015
Cold filter plugging point (CFPP)	°C	-	a)	IP 309
Pour point	°C	-	a)	ISO 3016
Total sediment by hot filtration	mass %	-	0.1	ISO 10307-1
Total sediment aged	mass %	-	0.1	ISO 10307-2

Characteristics	Unit	Min. limit	Max. limit	Test method reference
Ash	mass %	-	0.15	ISO 6245
Carbon residue (a) : micro method on the 10% volume distillation residue	mass %	-	0.3	ISO 10370
Carbon residue (b) : micro method	mass %	-	20	ISO 10370
Asphaltenes	mass %	-	8	-
Water	vol %	-	0.5	ISO 3733
Total Acid number (TAN)	mg KOH/g	-	2.5 b)	ASTM D664
Strong acid number	mg KOH/g	-	0	ASTM D664
Oxidation stability	g/m ³	-	25	ISO 12205
Hydrogen sulfide	mg/kg	-	2	IP 570
Copper strip corrosion (3h at 50°C)	Rating	1b	1a	ASTM D130
Lubricity, corrected wear scar diameter	µm	-	520	ISO 12156-1
Vanadium	mg/kg	-	450	IP 501 / IP 470 / ISO 14597
Sodium	mg/kg	-	100	IP 501 / IP 470
Aluminium + Silicon	mg/kg	-	60 c)	IP 501 / IP 470 / ISO 10478
Used lubricating oils (ULO):	-	-	-	IP 501 / IP 470 / IP 500
- Calcium (Ca)	mg/kg	30	-	
- Zinc (Zn)	mg/kg	15	-	
- Phosphorus (P)	mg/kg	15 d)	-	
Cetane number	-	51	-	ISO 4264
Alkali content (Na+K)	mg/kg	-	100	EN 14108 / EN 14109 / 14538
Alkali content (Ca+Mg)	mg/kg	-	30	EN 14538
Lead (Pb) content	mg/kg	-	10	ASTM D 5059
Steel corrosion (24/72h at 20, 60, 120degC)	rating	No signs of corrosion		LP 2902

Characteristics	Unit	Min. limit	Max. limit	Test method reference
Iodine number	g l/100g	-	120	ISO 3961
Oxidation stability	h	5	-	EN 14112
Synthetic polymers	%m	-	0	LP 2501
Lower calorific value	MJ/kg	35	-	DIN 51900-3

- a) The temperatures related to filterability have to be at least 10~15°C above the minimum fuel oil temperature (maximum temperature among cloud point, pour point, CFPP, and LTFT) in the whole fuel treatment process, even during engine stop unless flushing using pure diesel oil were performed before engine stop.
- b) It is required the agreement of FIP maker and HHI if the total acid number is more than 2.5 mg KOH/g.
- c) Aluminium and Silicon contents shall be less than 10 ppm at engine inlet although those contents is required less than 60 mg/kg in fuel oil.
- d) It is required the agreement of SCR maker if the project is required the SCR with engine.

6.4 Fuel oil viscosity diagram

The viscosity of heavy fuel oil to the engine should be kept within the value of 12 ~ 18 cSt. However, the viscosity varies depending on the properties and the temperature of the fuel oil. Maximum preheating temperature of heavy fuel oil is limited up to 155 °C to avoid the vaporization of the fuel oil. A typical fuel oil viscosity diagram with temperature is as follows :

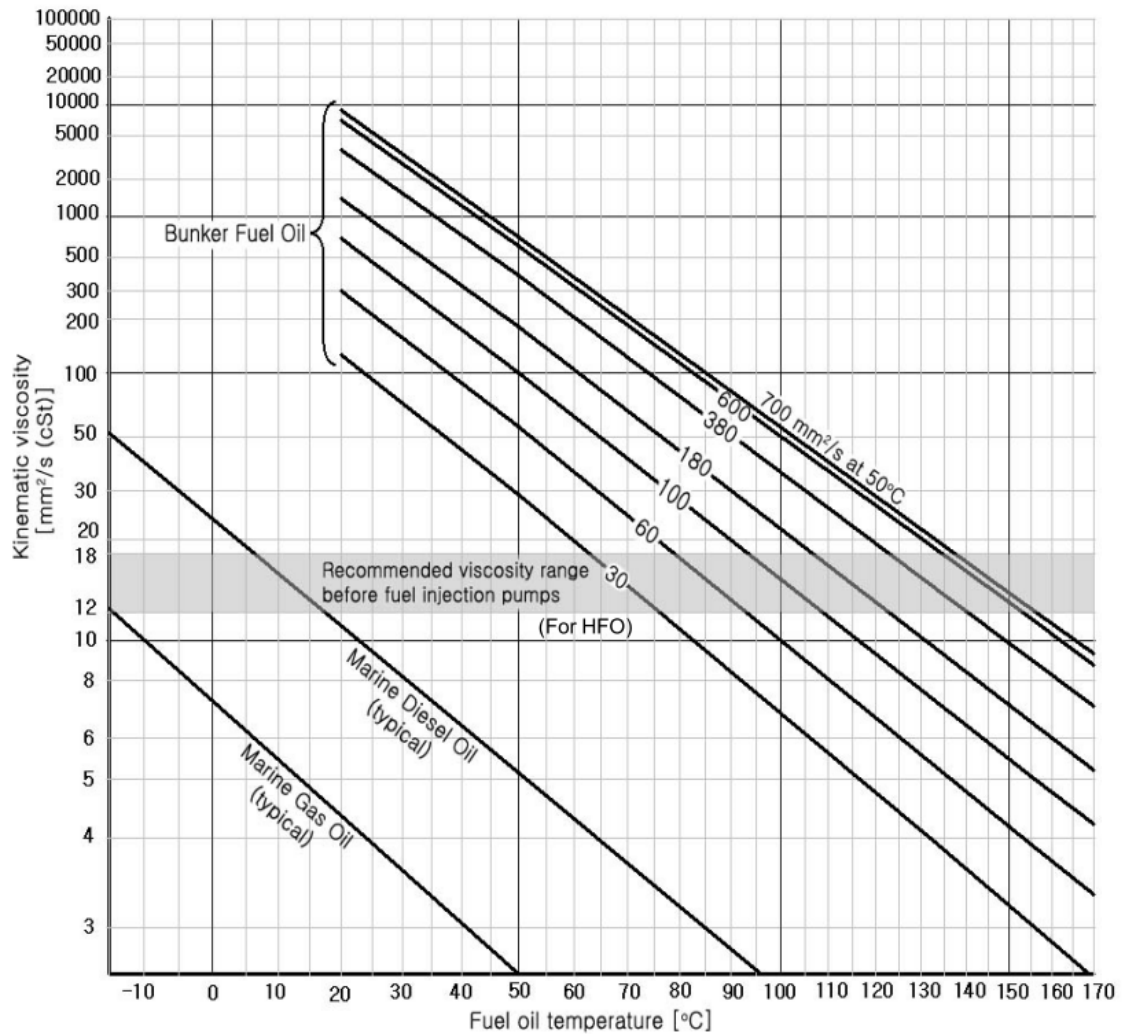

1. The viscosity of marine diesel oil / marine gas oil to the engine should be kept within the value of 2 ~ 14 cSt in order to avoid possible sticking of fuel injection pump due to low lubricity of marine diesel oil / marine gas oil.

Figure 6.4 Diagram for fuel oil viscosity

6.5 Fuel oil quality

6.5.1 Fuel characteristics

Viscosity

The viscosity of fuel oil to the engine should be kept within the value of 12 ~ 18 cSt for heavy fuel oil and 3 ~ 14 cSt for marine diesel oil / marine gas oil, which could be achieved by proper heating recommended by fuel supplier as the viscosity varies depending on the properties of the fuel oil.

Density

If the density of the fuel oil is over the maximum density (991 kg/m³ at 15 °C), the fuel oil is hard to be used because it is highly expected to be contaminated by water or solid unfiltered from system. The special centrifuging system should be installed for the fuel oil with the maximum density (1010 kg/m³ at 15 °C).

Sulfur

It is important to keep proper sulfur contents in the fuel oil. The high sulfur content in the fuel may increase the risk of low temperature corrosion in the combustion chamber and contribute to the formation of high temperature deposit. It is also recommended to keep the proper alkalinity of the lubricating oil for neutralizing.

Ash

The ash content comes from natural crude oil and also from contamination during treatment of the fuel. The solid ingredients can be removed mostly by centrifuging of the fuel. However there are soluble compounds such as vanadium and sodium, which can be transformed as ash after combustion. As the ash in any form promotes mechanical wear of engine parts and harmful deposits in the combustion chamber, the ash components should be carefully analyzed and removed in advance.

Vanadium and sodium

Vanadium is oil – soluble and comes from crude oil mostly. However sodium is water-soluble and comes from crude oil as well as contaminated fuel by salt water. As vanadium and sodium become corrosive ash after combustion, these should be removed as possible. A sodium compound contributes to lower the melting point of vanadium ash, which is very corrosive and harmful to exhaust valves and turbocharger. Therefore, compounds should be less than 1/3 of vanadium contents in weight.

Conradson carbon

Including much conradson carbon may impair combustion properties of the fuel and cause deposit formation in combustion chamber and exhaust system particularly at low engine output.

Asphaltenes

High asphaltene contents shall contribute to forming of deposit in combustion chamber as well as exhaust system at low loads and stick the fuel injection pump. It also causes excessive centrifuge sludge and deposits in the fuel system.

Water

The water contents can be measured by a standardized distillation test. The water causes corrosion and cavitation of the fuel injection pump and fouling of the exhaust system and turbochargers. The water content should be reduced to maximum 0.2 % by centrifuging.

Abrasive particles

Fuel oil can be contaminated by abrasive particles composed of aluminium and silicon. If the efficient fuel treatment is not applied, these fine catalysts can cause abnormal wear on injection system and cylinder liners / piston rings. The aluminum and silicon should be reduced to maximum 15 mg/kg before engine inlet.

6.5.2 Ignition quality

The ignition quality is related to the ignition delay to the intervals between fuel injection and combustion. If the engine is operated at low load or in the condition of low temperature or pressure in the combustion chamber, the ignition delay is lengthened. During the initial operation, the engine can be damaged by the low ignition quality without sufficient preheating. The equation of CCAI (Calculated Carbon Aromaticity Index) developed by Shell can be used to get the ignition quality of the heavy fuel oil.

Calculated carbon aromaticity index

$$CCAI = D - 81 - 141 \times \log \times [\log^x(Vk + 0.85)]$$

Where :

D (kg/m³ at 15 °C) = Density

Vk (cSt at 50 °C) = Viscosity

If the value of CCAI is increased, the ignition quality has decreased value. The fuel oil with high CCAI value can cause a combustion problem.

To prevent any troubles about poor ignition quality, engine should be preheated sufficiently before start and has proper functions of cooling system and injection system.

From light distillates to residual fuels, net and gross specific energy can be tested or calculated according to various international standards. Basically, the specific energy value provided by fuel supplier is adapted for the determination of the heat of combustion.

If it is not supplied from fuel supplier, it can be calculated by the specification of other properties as the equations given below.

For residual fuels,

$$N = (46.704 - 8.802 \times \rho^2 \times 10^{-6} + 3.167 \times \rho \times 10^{-3}) \times [1 - 0.01 \times (w + a + s)] + 0.0942 \times s - 0.02449 \times w$$

$$G = (52.190 - 8.802 \times \rho^2 \times 10^{-6}) \times [1 - 0.01 \times (w + a + s)] + 0.0942 \times s$$

For marine distillate fuels,

$$N = (46.423 - 8.792 \times \rho^2 \times 10^{-6} + 3.170 \times \rho \times 10^{-3}) \times [1 - 0.01 \times (w + a + s)] + 0.0942 \times s - 0.02449 \times w$$

$$G = (51.916 - 8.792 \times \rho^2 \times 10^{-6}) \times [1 - 0.01 \times (w + a + s)] + 0.0942 \times s$$

Where :

N (MJ/kg) = Net specific energy

G (MJ/kg) = Gross specific energy

ρ (kg/m³) = Density at 15°C

w (mass %) = Water content

a (mass %) = Ash content

s (mass %) = Sulfur content

Ref. ISO 8217:2017(E)

* Refer to that the actual specific energy test method (for example ASTM D 240) takes priority over the specific energy calculation method as above.

7 Lubricating oil system

7.1 Internal lubricating oil system

Diagram for Internal lubricating oil system

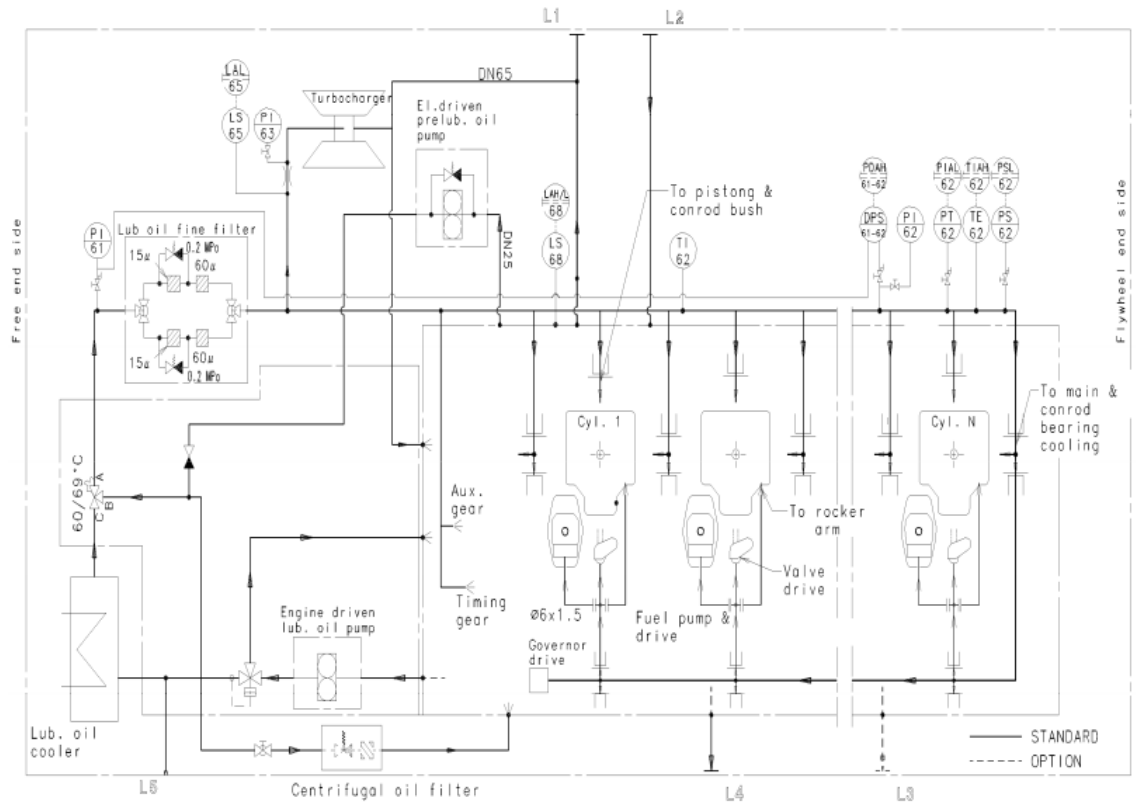

*) Scope of instrumentations will be according to extent of delivery and engine builder's standard.

Figure 7.1 Diagram for internal lubricating oil system

Table 7.1 Sizes of external pipe connections

Code	Description	Size
L1	Oil vapor discharger	50A
L2	Lubricating oil from separator / Supply	25A
L3	Lubricating oil over flow	40A
L4	Lubricating oil to separator	25A
L5	Cooling water automatic shut-off valve	PF1/4

1. Connection size is according to JIS B 2220.

7.1.1 General description

The engine has its own internal lubricating oil system with the wet type oil sump, which supplies lubricating oil to all moving parts for lubricating as well as cooling. Most of oil passages are incorporated into engine components and equipment in the system, which are mounted on free end side.

The internal lubricating oil system comprises following equipment :

- ✓ Lubricating oil cooler
- ✓ Engine driven lubricating oil pump (with pressure regulating valve)
- ✓ Electric motor driven pre-lubricating pump
- ✓ Lubricating oil thermostatic valve
- ✓ Lubricating oil filter
- ✓ Wet sump tank
- ✓ Centrifugal oil filter
- ✓ Oil mist detector(Optional)

Quantity of lubricating oil (wet sump)

Table 7.2 Total quantity of lubricating oil inside the engine

Engine type	Oil quantities in liter	
	Min.	Max.
6H17/28U	570	700
6H17/28E	480	600

Lubricating oil consumption

Specific lubricating oil consumption : 0.6 g/kWh

- ✓ Tolerance : +25 % depending on the operating condition
- ✓ Only maximum continuous rating should be used to evaluate the lubricating oil consumption.

Engine driven lubricating oil pump

The engine driven lubricating oil pump is a gear type, mounted on the free end side of the engine. The oil pressure is controlled by relief valve built on the pump.

Pre-lubricating oil pump

The pre-lubricating pump is gear type, and electric motor driven. The pre-lubricating pump is operated continuously during engine stand-still in stand-by condition. And the pre-lubricating is required during the engine stop period if the fuel oil is circulating. In case that the automatic pre-lubrication has been switched off, the engine must be pre-lubricated sufficiently before starting up.

Lubricating oil cooler

The lubricating oil cooler is plate type, mounted on the exhaust side of the engine.

Thermostatic valve

The thermostatic valve is the wax element type, working at fixed temperature range of 60 ~ 69 °C, is mounted on cooler module of the engine.

Lubricating oil filter

The lubricating oil filter is duplex paper cartridge type, mounted on the exhaust side of the engine. Each filter has a safety cartridge of stainless steel.

- ✓ Paper cartridge fineness : 15 μm
- ✓ Safety cartridge fineness : 60 μm

Pressure regulating valve

The pressure regulating valve adjusts inlet pressure after lubricating oil filter at 4 ~ 5 bar and is mounted on engine driven lubricating oil pump.

Centrifugal oil filter

Centrifugal oil filter can be mounted on engine. The centrifugal force is taken from the oil pressure.

Lubricating oil sump drain

It is recommended to use the separator suction pipe for draining of the lubricating oil sump.

7.2 External lubricating oil system

Diagram for external lubricating oil system

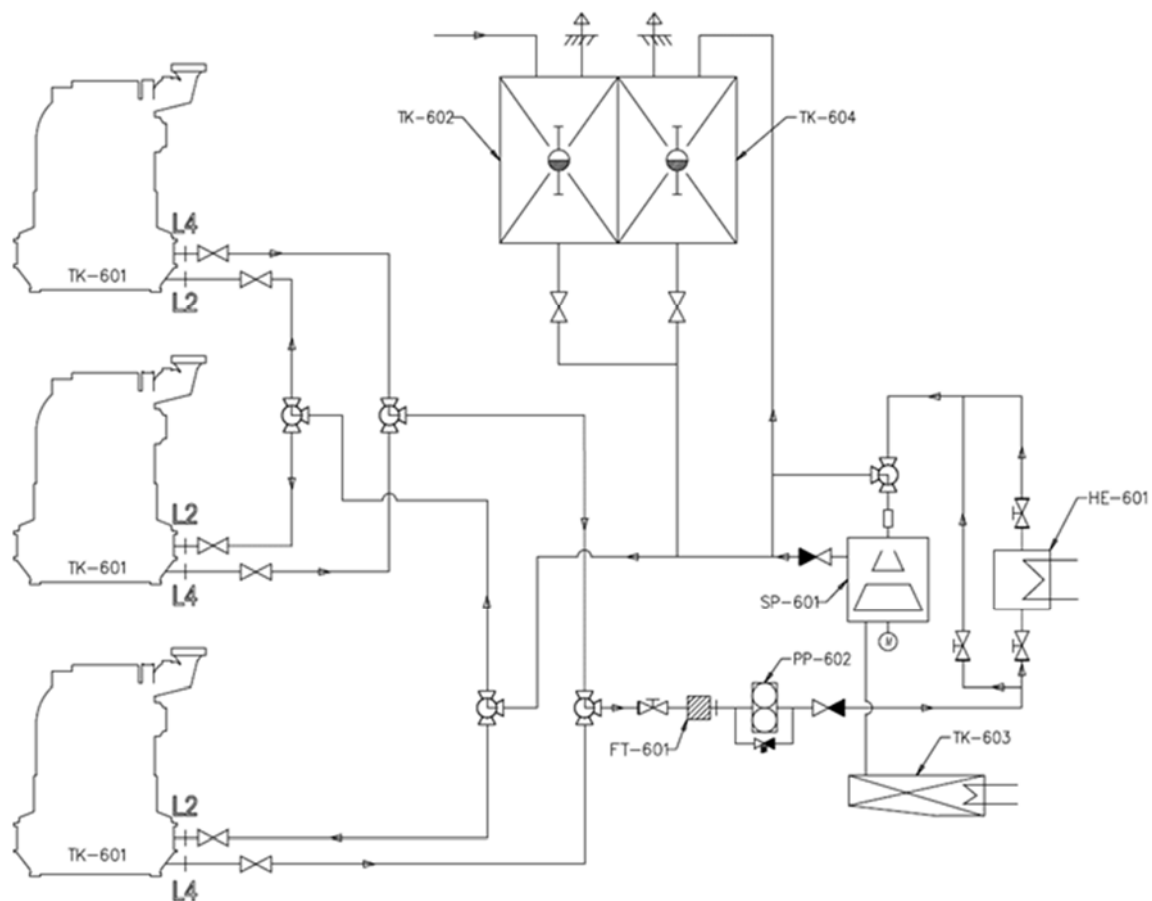

Figure 7.2 Diagram for external lubricating oil system for multi-engine installation (B91-314112-7.1)

Table 7.3 System components

Code	Description	Code	Description
TK-601	System oil tank	HE-601	Pre-heater for the separator
TK-602	Storage tank	SP-601	Separator
TK-603	Sludge tank	PP-602	Feed pump for the separator
TK-604	Separated oil tank	FT-601	Suction strainer

7.2.1 General description

The external lubricating oil system is required for not only cleaning but also heating the oil to start the engine quickly. The system shall be used commonly for all auxiliary engines. Though filtering equipment built on engine shall be sufficient for the engine operating only marine diesel oil, the centrifugal purification is commonly required for marine diesel oil and heavy fuel oil operation.

7.2.2 Lubricating oil separator

Self-cleaning type or manual cleaning type separator can be used.

Separator capacity

The separators should be dimensioned for continuous operation and following formula can be used, as a guidance, for estimating the required flow for the separator capacity :

$$F = p \times 1.4 \times n / t$$

Where :

F (l/h) = required flow

p (kW) = total engine output

n = number of oil circulation per day (4 for marine diesel oil / marine gas oil, 6 for heavy fuel oil)

t = actual separation time per day (Normally, 23 hour)

For the simple estimation, above formula can be expressed as follows :

$$F = 0.3 \times p \text{ (l/h)}$$

The below formula is used to find the rated capacity for the separator :

$$V = F / B \text{ (l/h)}$$

Where :

V (l/h)= rated capacity for the separator

F (l/h) = required flow

B = throughput factor (0.2 ~ 0.25)

Throughput factor (B) shall be in accordance with the separator maker's recommendations.

Separator installation

The separator should be in continuous operation while the engine is on running in order to ensure removal of contaminants as quick as possible. If possible, the separator should be in operation also when the engine on shut-down for the reducing of the contamination level. In the latter case, oil temperature for efficiencies of separation needs to be maintained through heaters. Those installations with their separation plant shut down during engine stop, should consider re-starting the separator prior to engine start-up because contamination (engine leaks, condensation) could occur during engine stop.

With multi-engine plants, it would be the best to install one separator per each engine (Figure 7.3). The cleaning systems of auxiliary engines are often designed such that the separator intermittently serves on engine at a time. If only one separator is in operation, the following layouts can be used (Figure 7.4).

Oil cleaning, the discharge depending upon the operating time between two periods of oil cleaning the discharge interval may have to be shortened during the first couple of hours. In this way the separator will be able to cope with the high level of contaminants at the beginning of the cleaning phase. The appropriate discharge interval has to be found by trial and error.

It is important that maintenance and operation of the separator should be performed according to the manufacturer's recommendations.

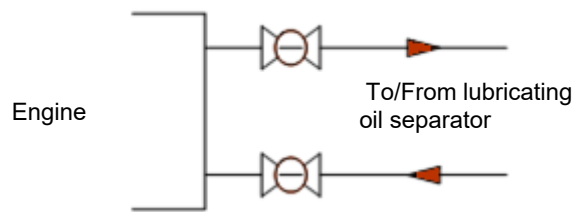

Figure 7.3 Principle layout for direct separating on single engine.

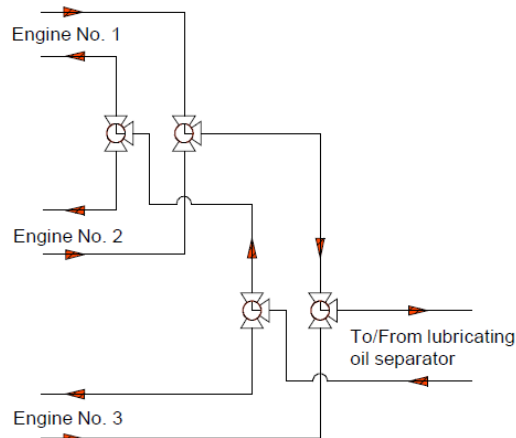

Figure 7.4 Principle layout for direct separating on multi engines

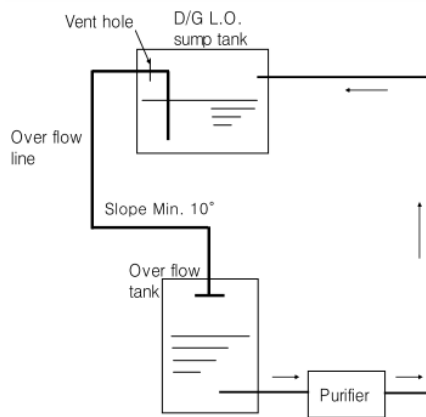

Figure 7.5 Principle layout for overflow system

It should be ensured that the separator is only connected with one engine at a time. In order to ensure that there is no suction and discharging from one engine to another.

To provide the mentioned above, it is recommended that inlet and outlet valves are connected, so that they can be changed-over simultaneously.

With only one engine in operation there are no problems with separating, but if multi engines are in operation for some time it is recommended to split up the time so that there is separation on all engines, which are operating in turns.

Overflow system

In some cases, overflow system can be applied as an alternative for continuous purification (Figure 7.5). In order to have a better syphon effect, the overflow pipe from sump to overflow tank should have a continuous downward gradient of minimum 10 degrees without high and low point.

Suction strainer

0.8 ~ 1.0 mm mesh size of suction strainer should be inserted before the separator pump.

Pump for separator

The pump can be either directly driven by the separator or driven by an independent motor as recommended from a separator maker.

Heater for separator

The lubricating oil in wet sump tank and in the system is to be warm-up to 40 °C from the separator heater prior to engine starting. The lubricating oil in sump tank is to be heated-up to approx. 65 °C in engine service. Heater for separator is to be designed to heat the lubricating oil from 65 °C up to 95 ~ 98 °C according to separator maker's recommendation.

If the separation temperature is lowered from 95 °C to 90 °C, the separator throughput has to be reduced by 22 % to maintain the same separation efficiency.

7.2.3 Velocities and pressure losses

In order to prevent excessive pressure losses in the piping system, we recommend that the lubricating oil velocity should not exceed :

- ✓ Suction pipe : 0.5 ~ 1.5 m/s
- ✓ Pressure pipe : 1.0 ~ 2.5 m/s

7.2.4 Crank case ventilation

Where two or more engines are installed, vent pipes, if fitted, and lubrication oil drain pipes should be independent to avoid inter circulation between crankcases.

- ✓ The crankcase vent pipes from each engine shall be led independently to the top of the funnel. The pipes should not be connected to any other branch such as a tank vent, etc.
- ✓ The outlet of vent pipe is to be fitted with corrosion resistant flame screen separately for each engine.
- ✓ The vent pipe should have a continuous upward gradient of minimum 10 degrees without high point or low point.
- ✓ The vent pipe should be equipped with a condensate trap and drain near the engine.
- ✓ The connection between the engine and yard vent pipe is to be flexible, if resilient mounting is applied.
- ✓ The dimension of the flexible connection is 65A, and the vent pipe size after the flexible connection must be min. 65A.
- ✓ The oil mist should not be go into suction side of intake duct located outside (for outdoor type) or engine room (for indoor type)
- ✓ Criteria for high back pressure of crank case ventilation is that the maximum crank case inner pressure should not exceed 30 mmWC at maximum continuous rating.

7.3 Lubricating oil specification

7.3.1 Oil grade

The medium-alkaline, heavy duty (HD) oils in API-CD class have to be used for HiMSEN engine including turbocharger lubrication. Please refer to the Table 7.5.

7.3.2 Oil viscosity

The oil viscosity is based on SAE 40 oil and recommended to be 145 mm²/sec. at 40 °C.

The lubricating oil should be heated to 40 °C prior to engine start.

7.3.3 Governor oil grade

In case of the hydraulic governor, an independent oil system is required. For further information, please refer to the Table 7.5.

BN value

BN (Base Number) is a measure of the alkalinity or basicity of the oil. It is expressed in milligrams of potassium hydroxide per gram of the oil (mg KOH/g).

Alkalinity in lubricating oil is necessary to neutralize the acidic combustion products coming from the sulfur in fuel. Therefore, lubricating oil with suitable BN should be selected to maintain proper balance between alkalinity in lubricating oil and the sulfur level in fuel after consulting with lubricating oil supplier or specialist.

- ✓ High sulfur fuel + low BN lubricating oil → Excessive corrosive wear
- ✓ Low sulfur fuel + high BN lubricating oil → Excessive top land deposit formation
→ Lacquering formation on cylinder liner surface

7.3.4 Lubricating oil selection

The general lubricating oil BN selection strategy is to match the lubricating oil with the fuel sulfur contents (%). Because BN decreases at various rates in each engine and condition, lubricating oil consumption also should be considered to have sufficient equilibrium during operation.

When the marine diesel oil / marine gas oil is to be used only for temporary engine operation, higher BN lubricating oil used for residual fuel (heavy fuel oil) would not present any problems. The acceptable period of temporary operation is less than 200 hours.

It is necessary to use proper lubricating oil based on sulfur content of fuel as per the lubricating oil list for HiMSEN engine described on the instruction manual in order to avoid excessive deposits in the combustion chamber, exhaust gas line and turbochargers.

Residual fuel

Table 7.4 Residual fuel

Sulfur contents (%)	BN
3.5 -	40 - 55
0.5 - 3.5	30 - 40
0.1 - 0.5	20 - 30
- 0.1	20

Distillated fuel

- ✓ Distillated fuel (marine gas oil / marine diesel oil) : BN10 ~ 20

* Refer to the Sheet '6.3 Fuel oil specification' for specification of residual and distillated fuel.

7.4 List of lubricants

Table 7.5 List of lubricants

Oil brand	Engines system lubricating oil			Governor oil
Oil company	Brand name	SAE	BN ¹⁾	
Shell	Mysella S3 N40	40	5	1) Same as engine system lubricating oil 2) Refer to the governor manual for detailed lubricating oil specification, volume of governor. 3) Initial filling : oil filled 4) Electrical (Digital) governor: not applied
	Mysella S5 N40		4.5	
	Shell Gadinia S3 40		12	
	Shell Argina S2 40		20	
	Shell Argina S3 40		30	
	Shell Argina S4 40		40	
	Shell Argina S5 40		50	
TOTAL (Lubmarine)	Aurelia LNG	40	5	
	Nateria X 405		5.2	
	DISOLA M 4012		12	
	DISOLA M 4015		14	
	AURELIA TI 4020		20	
	AURELIA TI 4030		30	
	AURELIA TI 4040		40	
AURELIA TI 4055	55			
Chevron (Taxaco, Caltex)	HDAX 9700	40	5.8	
	DELO SHP 40		12	
	DELO 1000 Marine 40		12	
	TARO 20 DP 40(X)		20	
	TARO 30 DP 40(X)		30	
	TARO 40 XL 40(X)		40	
ExxonMobil	Pegasus 805 Ultra	40	5.4	
	Pegasus 805		6.2	
	Pegasus 1005		5.4	
	Pegasus 1105		6.2	
	Pegasus 1107		7.3	
	Pegasus 1		6.5	
	Mobilgard ADL 40, Mobil Delvac 1640		12	
	Mobilgard 412		15	
	Mobilgard M420		20	
	Mobilgard M430		30	
	Mobilgard M440		40	
BP (Castrol)	CASTROL Duratex L	40	4.5	
	CASTROL MLC 40		12	
	CASTROL MHP 154		15	
	CASTROL TLX Xtra 204		20	
	CASTROL TLX Xtra 304		30	
	CASTROL TLX Xtra 404		40	
	CASTROL TLX Xtra 504		50	
	CASTROL TLX Xtra 554		55	
SK Lubricants	SUPERMAR 13TP 40	40	13	
	SUPERMAR 24TP 40		24	
	SUPERMAR 30TP 40		30	
	SUPERMAR 40TP 40		40	
LUKOIL	Navigo TPEO 12/40	40	12	
	Navigo TPEO 15/40		15	
	Navigo TPEO 20/40		20	
	Navigo TPEO 30/40		30	
	Navigo TPEO 40/40		40	
	Navigo TPEO 50/40		50	
Navigo TPEO 55/40	55			

Oil brand	Engines system lubricating oil			Governor oil
Oil company	Brand name	SAE	BN ¹⁾	
Gulf Oil Marine	GulfSea Power MDO 4012, SeaLub Power MDO 4012	40	12	1) Same as engine system lubricating oil 2) Refer to the governor manual for detailed lubricating oil specification, volume of governor. 3) Initial filling : oil filled 4) Electrical (Digital) governor: not applied
	GulfSea Power MDO 4015, SeaLub Power MDO 4015		15	
	GulfSea Power MDO 4020, SeaLub Power MDO 4020		20	
	GulfSea Power 4030, SeaLub Power 4030		30	
	GulfSea Power 4040, SeaLub Power 4040		40	
	GulfSea Power 4055, SeaLub Power 4055		55	
ENI S.p.A.	AGIP CLADIUM 120	40	12	
	AGIP CLADIUM 300		30	
	AGIP CLADIUM 400		40	
	AGIP CLADIUM 500S		50	
Petronas	PETRONAS Disrol 50	40	6	
	PETRONAS Disrol 120		12	
	PETRONAS Disrol 300		32	
	PETRONAS Disrol 400		42	
	PETRONAS Disrol 500		51	
AEGEAN	ALFAMAR 430	40	30	
	ALFAMAR 440		40	
	ALFAMAR 450		50	
	ALFAMAR 455		55	
SINOPEC TPEO	SINOPEC TPEO 4012	40	12	
	SINOPEC TPEO 4015		15	
	SINOPEC TPEO 4020		20	
	SINOPEC TPEO 4030		30	
	SINOPEC TPEO 4040		40	
	SINOPEC TPEO 4050		50	
Hyundai Oilbank	Hyundai XTeer HGSL 40	40	4.5	
	Hyundai XTeer TPEO 4012		12	
	Hyundai XTeer TPEO 4015		15	
	Hyundai XTeer TPEO 4020		20	
	Hyundai XTeer TPEO 4030		30	
	Hyundai XTeer TPEO 4040		40	
	Hyundai XTeer TPEO 4050		50	
Gazpromneft Lubricants	Gazpromneft Ocean TPL 1240	40	12	
	Gazpromneft Ocean TPL 1540		15	
	Gazpromneft Ocean TPL 2040		20	
	Gazpromneft Ocean TPL 3040		30	
Petro-Canada	Sentinel 445	40	4.7	
Oil volume	See the separate data for sump volume as per each engine type.			UG-25+: 2.1 Liter Europa : 1.5 Liter

1. This list is given as guidance only.

*) Refer to Table 7.4 when selecting BN value.

This page is intentionally blanked

8 Cooling water system

8.1 Internal cooling water system

Diagram for internal cooling water system - 1

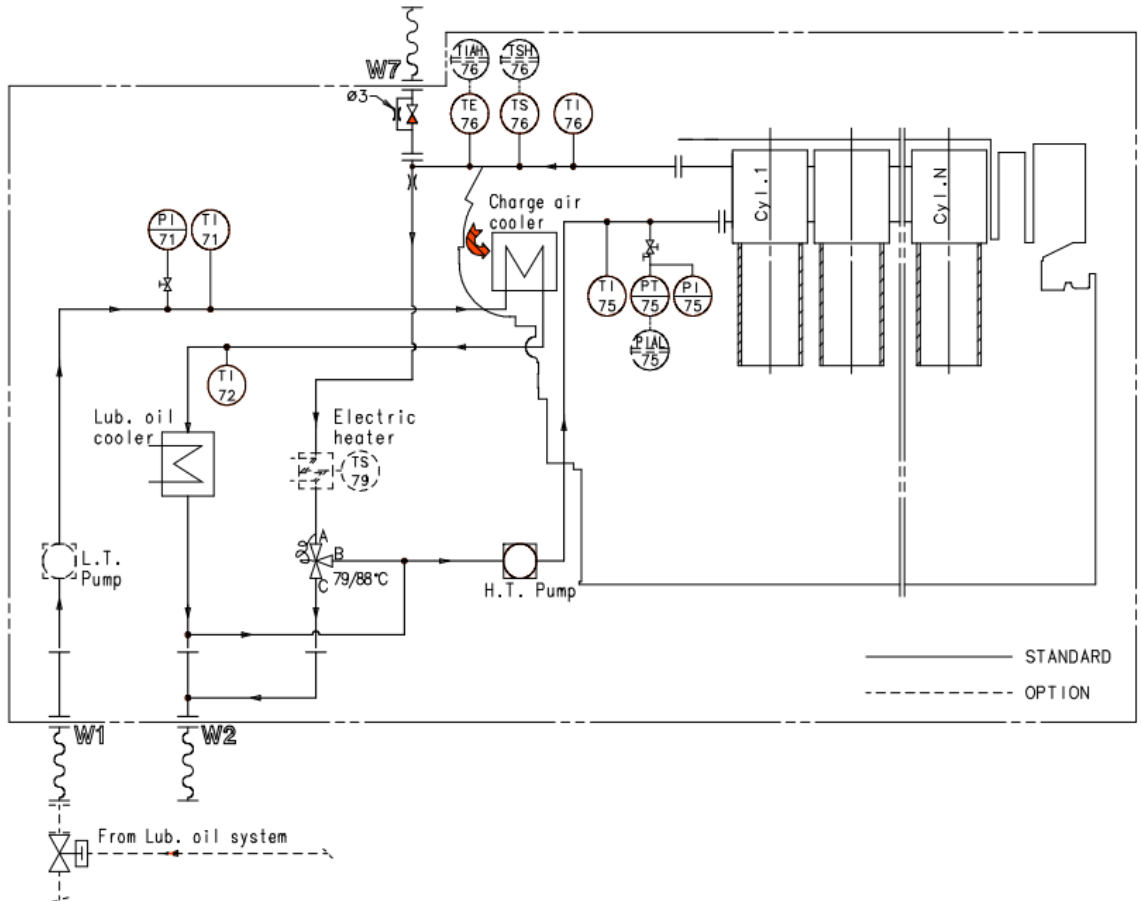

°) Scope of instrumentations will be according to extent of delivery and engine builder's standard.

Figure 8.1 Diagram for internal cooling water system -1

Table 8.1 Sizes of external pipe connections

Code.	Description	Size
W1	Low temperature cooling water engine inlet	65A
W2	Low temperature cooling water engine outlet	65A
W7	Ventilation to expansion tank	15A

1. Connection size is according to JIS B 2220.

Diagram for internal cooling water system - 2

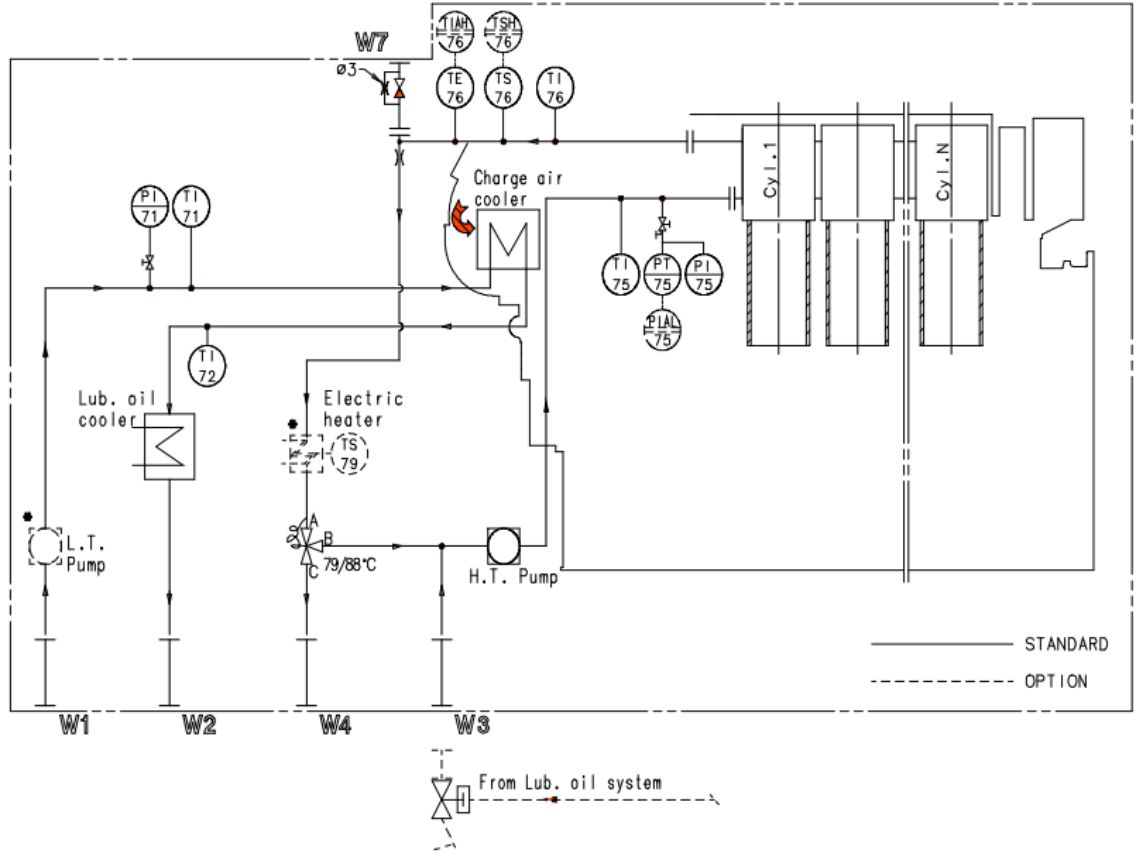

*) Scope of instrumentations will be according to extent of delivery and engine builder's standard.

Figure 8.2 Diagram for internal cooling water system - 2

Table 8.2 Sizes of external pipe connections

Code.	Description	Size
W1	Low temperature cooling water engine inlet	65A
W2	Low temperature cooling water engine outlet	65A
W3	High temperature cooling water engine inlet	65A
W4	High temperature cooling water engine outlet	65A
W7	Ventilation to expansion tank	15A

1. Connection size is according to JIS B 2220.

8.1.1 General description

The engine has two cooling water circuits internally, which are low temperature and high temperature water circuits.

Low temperature water circuit comprises :

- ✓ Engine driven pump (option)
- ✓ Charge air cooler
- ✓ Lubricating oil cooler

High temperature water circuit comprises :

- ✓ Engine driven pump
- ✓ Engine block and cylinder heads
- ✓ Wax type thermostat valve, dividing type (temp. set point : 82°C)

Scope of supply

The internal cooling system consists of the following built-in equipment. Marked (*) equipment can be supplied as option on request.

- ✓ * Engine driven low temperature cooling water pump (option)
- ✓ Engine driven high temperature cooling water pump
- ✓ One stage charge air cooler
- ✓ High temperature cooling water control thermostatic valve
- ✓ * Electric pre-heater unit or electric preheat element on engine (option)

Low temperature cooling water control thermostatic valve, if required, to be installed on external piping.

8.2 External cooling water system

Diagram for external cooling water system – 1 with jacket preheating unit (for reference)

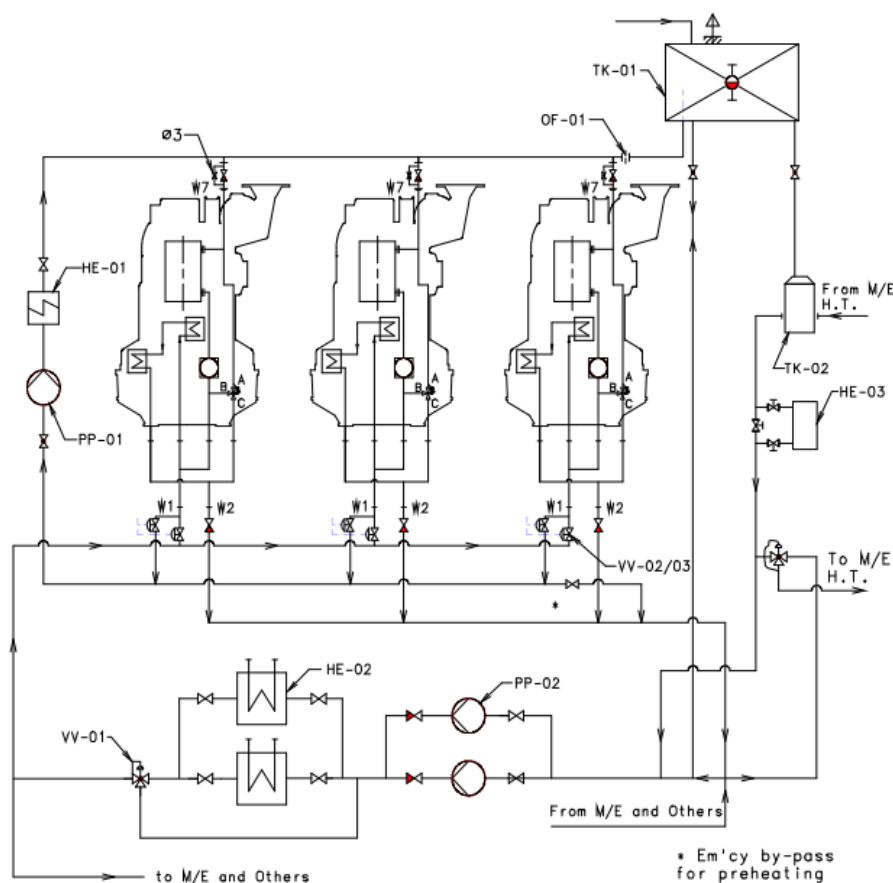

Figure 8.3 Diagram for external cooling water system-1 (pre-heating unit)

Table 8.3 System components

Code	Description	Code	Description
TK-01	Expansion tank	PP-02	Central cooling water pump
HE-01	Electric Pre-heater	VV-02/03	Auto shut-off valve
PP-01	Pre-heating pump	OF-01	Orifice (Ø3)
TK-02	Deaerating tank	VV-01	Thermostatic valve for central cooling
HE-02	Central cooler	HE-03	Fresh water generator

Diagram for external cooling water system – 2 with jacket preheating unit (for reference)

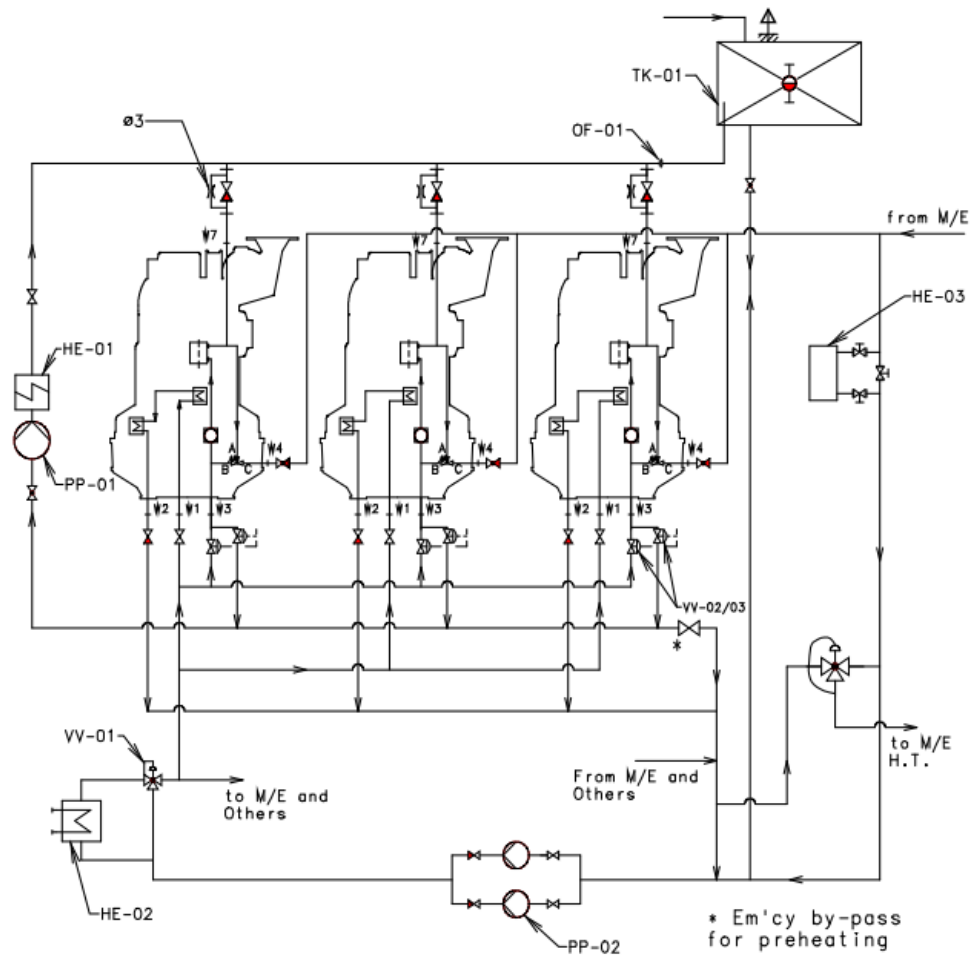

Figure 8.4 Diagram for external cooling water system -2 (pre-heating unit)

Table 8.4 System components

Code	Description	Code	Description
TK-01	Expansion tank	PP-02	Central cooling water pump
HE-01	Electric pre-heater	VV-02/03	Auto shut-off valve
PP-01	Pre-heating pump	OF-01	Orifice (Ø3)
HE-03	Fresh water generator	VV-01	Thermostatic valve for central cooling
HE-02	Central cooler		

8.2.1 General description

The engine has two cooling circuits of low temperature cooling water and high temperature cooling water internally. However, the external connections can be provided for one (system-1) or two string (system-2) cooling circuits.

Pressure drop

- ✓ Engine high temperature cooling water system : approx. 0.5 bar
- ✓ Charge air cooler : approx. 0.5 bar
- ✓ Lubricating oil cooler : approx. 0.5 bar
- ✓ Thermostatic valve : approx. 0.5 bar

(These values shall be different depending on the actual design of each vessel or plant.)

Fresh water velocity

- ✓ Suction pipe : 1.5 ~ 2.0 m/s
- ✓ Delivery pipe : 2.0 ~ 2.5 m/s

Sea water velocity

- ✓ Suction pipe : 1.0 ~ 1.5 m/s
- ✓ Delivery pipe : 1.5 ~ 2.5 m/s

Expansion tank

To avoid cavitation in cooling water system, a certain suction head for engine driven cooling water pump is required as follows :

- ✓ Minimum head : 0.5 bar (5 meters above the crank shaft level)
- ✓ Tank volume : 100 liter + α^1

1. α : min. 10 % of high temperature cooling water and low temperature cooling water volume of additional engine(s).

Table 8.5 Cooling water volume of the engines

Engine type	High temperature cooling water and low temperature cooling water volume
6H17/28U	161 liter
6H17/28E	158 liter

Central cooling

The central cooler for fresh water can be of the tube or plate type, which can be common for several engines or separate for each engine.

1) Fresh water side

- ✓ Flow quantity and heat dissipation : Refer to '3.2 engine capacity data'.
- ✓ Pressure drop : maximum 0.5 bar.
- ✓ Pump : centrifugal type (Electric motor driven)
- ✓ Water temperature before engine : 36 °C

2) Sea water side

- ✓ Flow quantity : 1.5 times of fresh water flow
- ✓ Pressure drop : 1.0 ~ 1.5 bar

8.2.2 Cooling water pressure of engine inlet

Pressure of engine inlet should be kept under 2.5 bar.

8.2.3 Cooling water

The cooling water system is designed for using normal fresh water (hardness < 10°dH, pH > 10) with dosing corrosion inhibitor.

If sea water or other coolant system should be applied, please contact the engine maker separately in advance.

Pre-heating

In order to ensure start of engine and quick load up, pre-heating facility must be installed on the internal or external cooling water circuit. Pre-heating for all engines are required.

Pre-heating temperature :

- ✓ Marine diesel oil operation : minimum 40 °C
- ✓ Heavy fuel oil operation : minimum 60 °C

Electric pre-heating element (Option)

The mount type on the cooling water preheating arrangement consists of a thermostat-controlled electric-heating element which is built in high temperature cooling water circuit located on engine. The pre-heater is activated by thermostat at 60 °C which provides water (60 °C) to high temperature cooling water outlet.

Table 8.6 Recommended capacity of pre-heater

Engine type	Electric pre-heater (kW)
6H17/28U	6.0
6H17/28E	6.0

1. The biggest capacity is applied for all cylinder for better heating effect

Operation

Before the engine starts on heavy fuel oil / marine diesel oil, the engine jacket must be pre-heated by pre-heater.

It is recommended that the pre-heater is arranged for automatic operation, so that the pre-heater shall be disconnected while the engine is running and connected while the engine is stand-by condition.

When the engine is in standstill, an external valve for pre-heater must be shut off the cooling water inlet.

Preheating unit (Option)

External pre-heating unit comprising with the follows can be supplied as option :

- ✓ Electric or steam heater
- ✓ Circulating water pump
- ✓ Control panel and circulating pump starter
- ✓ Switch on-off of heating media

The capacity of external pre-heater should be 1.5 kW per cylinder. The flow through the engine for each cylinder should be approx. 1.5 liter / min. with flow top and downwards.

Auto shut off valve must be installed on the external cooling water system to ensure preheating, which prevents cooling water from flowing into the engine during preheating.

Preheating of stand-by engine

When only one engine sets are in service and others in stand-by, cold cooling water should not be passed into the cooling jackets on stand-by engines, which will cause cold corrosion in cooling system.

Stand-by engines should be kept warm condition through heating source such as thermal heating through venting pipe from a running engine or pre-heater.

8.3 Cooling water quality and treatment

8.3.1 Quality of cooling water

The cooling of the engine should be done by only distilled (demineralized) or fresh water, which should be checked and treated to satisfy following requirements below table before adding corrosion inhibitor.

It is necessary for keeping effective cooling and preventing corrosion of the system.

Though the distilled water fully satisfy to the requirements for cooling water, it is necessary to add corrosion inhibitor before applying cooling water to engine cooling water system because untreated cooling water absorbs carbon dioxide from the air and then becomes corrosive.

Table 8.7 Quality of cooling water

pH	7 to 9
Total Hardness as CaCO ₃	Maximum 75 ppm (mg/l)
Chlorides Cl ⁻	Maximum. 80 ppm (mg/l)
Sulphates as SO ₄ ²⁻	Maximum 100 ppm (mg/l)
Silica as SiO ₂	Maximum 60 ppm (mg/l)
Residue after evaporation	Maximum 400 ppm (mg/l)

1. Chloride and Sulphate are corrosive even in the presence of an inhibitor.

Sea water or fresh water contaminated by sea water even in small amount is not allowed to be used as cooling water of the engine due to high risk of severe corrosion and deposits formation in the system.

Rainwater is heavily contaminated and highly corrosive in general, which is also not recommended as cooling water.

Tap water (drinking water) is not recommended as cooling water due to risk of chalk deposit formation inside the cooling system.

However, if the distilled water, for example from fresh water generator, is not available, tap water may be used as cooling water after softening and some other treatments according to the ingredients.

8.3.2 Treatment of cooling water

Cooling water should be treated properly and corrosion inhibitor should be added.

The analysis and treatment of cooling water are recommended to be carried out by experts. Otherwise, comply the treatment procedures strictly according to the instructions from the supplier.

The recommended products are listed in following table.

Table 8.8 Recommended products list

Manufacturer	Brand name	Constituent	Delivery form	Recommended Dosage
Chevron (FAMM)	DELO XLI(Havoline XLI)	Carboxylates	Liquid	75 liter / 1000 liter
VECOM	Cooltreat NCLT	Nitrite	Liquid	48 liter / 1000 liter
Wilhelmsen Chemicals	Rocor NB	Nitrite, Borate	Liquid	63 liter / 1000 liter
NALCO	NALCOOL2000	Nitrite, Borate	Liquid	128 liter / 1000 liter
	TRAC100	Molybdate, silicate	Liquid	17.5 liter / 1000 liter
	TRAC115,TRAC108	Nitrite, Borate	Liquid	28 liter / 1000 liter
GE Water and Process Technologies	CorrShield NT4200	Nitrite	Liquid	30 liter / 1000 liter
Shell	Shipcare Cooling Water Treat	Nitrite, Borate	Liquid	128 liter / 1000 liter
Drew marine	LIQUIDEWT	Nitrite	Liquid	24 liter / 1000 liter
	MAXIGARD	Nitrite	Liquid	64 liter / 1000 liter

1. Follow the guidelines of corrosion inhibitor manufacturer for cooling water treatment.
2. Oily inhibitors adhere to cooling surface and influence cooling efficiency, which are not recommended for cooling water. Only nitrite-borate based inhibitors are recommended.
3. Some inhibitors may be toxic and hazardous. Strict control is required when handling inhibitors.

9 Air and exhaust gas system

9.1 Internal compressed air system

Diagram for internal compressed air system

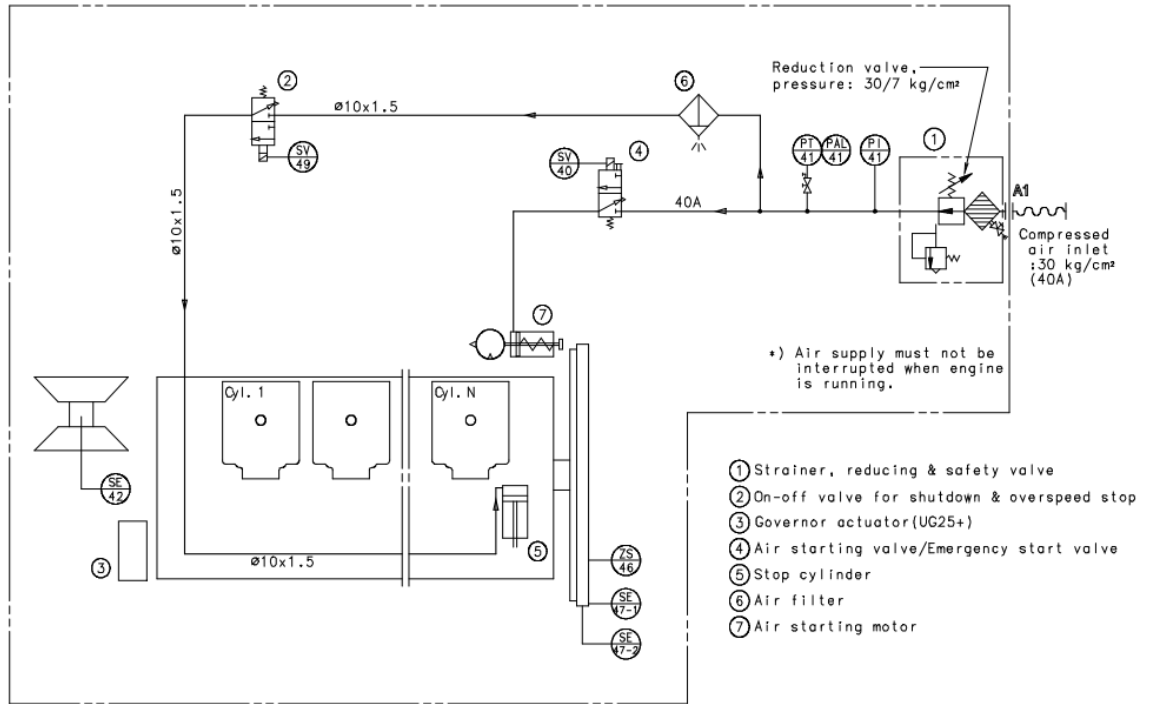

*) Scope of instrumentations will be according to extent of delivery and engine builder's standard.

Figure 9.1 Diagram for internal compressed air system.

Table 9.1 Size of external pipe connection

Code.	Description	Size
A1	Compressed air inlet	40A

1. Connection size is according to JIS B 2220.

9.1.1 General description

Compressed air of min. 16 bar to max. 30 bar is supplied for engine start, emergency stop and safety system as for the control air. The detail information of engine operation is explained in the chapter '5. Operation and control system'.

Starting system

Starting system mainly consists of air starting valve and starting air motor unit for starting the engine by turning flywheel with gears. The compressed air is directly delivered to the air start motor through reduction valve.

Engine stopper

Engine stopper consists of stop solenoid valve with stop cylinder and governor with stop solenoid valve.

Fuel limiter unit

Fuel limiter unit is provided for governor of Woodward UG type, which limits the amount of fuel during engine starting.

Scope of supply

The compressed air system consists of the following equipment :

- ✓ Engine starter complete
- ✓ Shut down & Overspeed stop sol. valve
- ✓ Air cylinder for emergency stop

9.2 External compressed air system

Diagram for external compressed air system

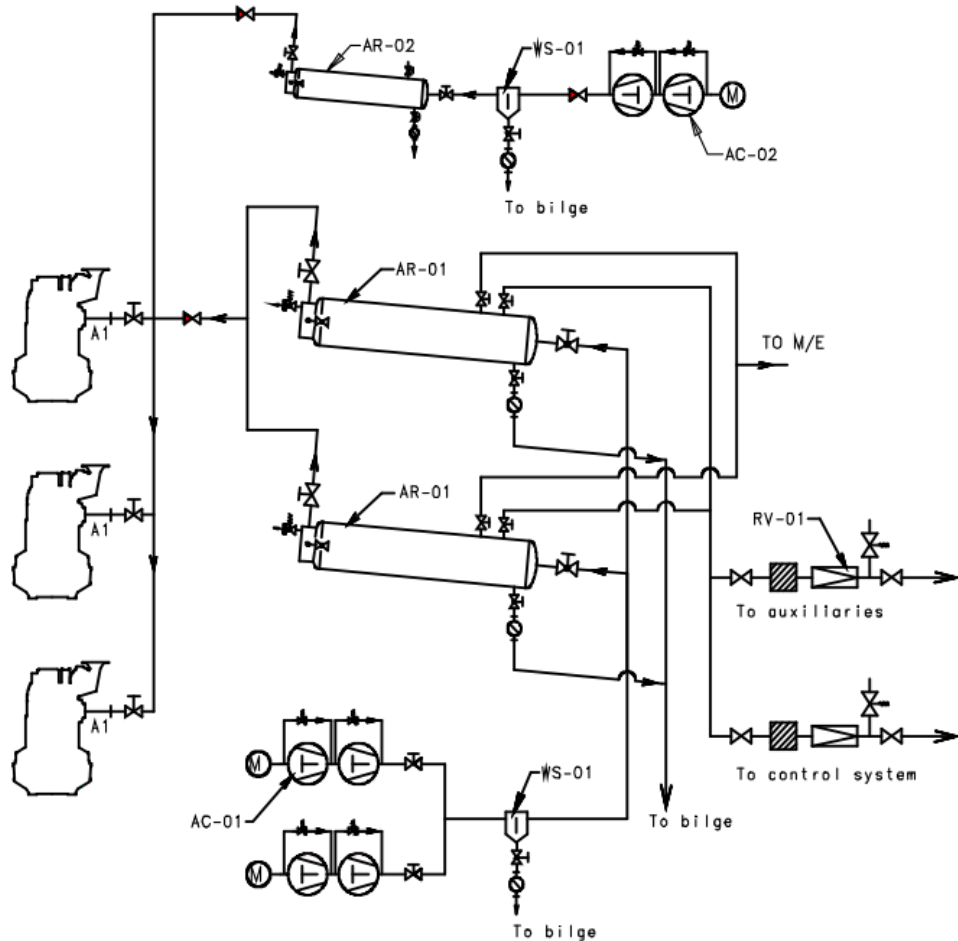

Figure 9.2 Diagram for external compressed air system

Table 9.2 System components

Code	Description	Code	Description
AR-01	Main air receiver	WS-01	Oil and water separator
AR-02	Aux. air receiver	RV-01	Reduction station
AC-01	Main air compressor	AC-02	Emergency air compressor

9.2.1 General requirements

The maximum 30 bar for the compressed air system is required for engine operation. Therefore, all external supply system should be properly designed for this nominal pressure and also should satisfy the rules of corresponding classification society.

Dry and clean air is essential for the reliable function of the engine starting and control system.

Therefore, the compressed air supply system should include oil and water separating equipment. The air supply pipe to engine should also be arranged with slope and the water trap should be positioned at the lowest points.

9.2.2 Starting air volume of the engine

Air consumption per one start is specified in '3.2 engine capacity data'. The capacity of starting air vessel varies as per Classification Societies or Customer's requirement. Volumes for three starts(include jet assist air volume) of one auxiliary engine are as follows;

Table 9.3 Starting air volume of the engines

Engine type	Volume (liter)
3 x 6H17/28U	410
3 X 6H17/28E	410

9.3 Internal combustion air system

Diagram for internal combustion air system

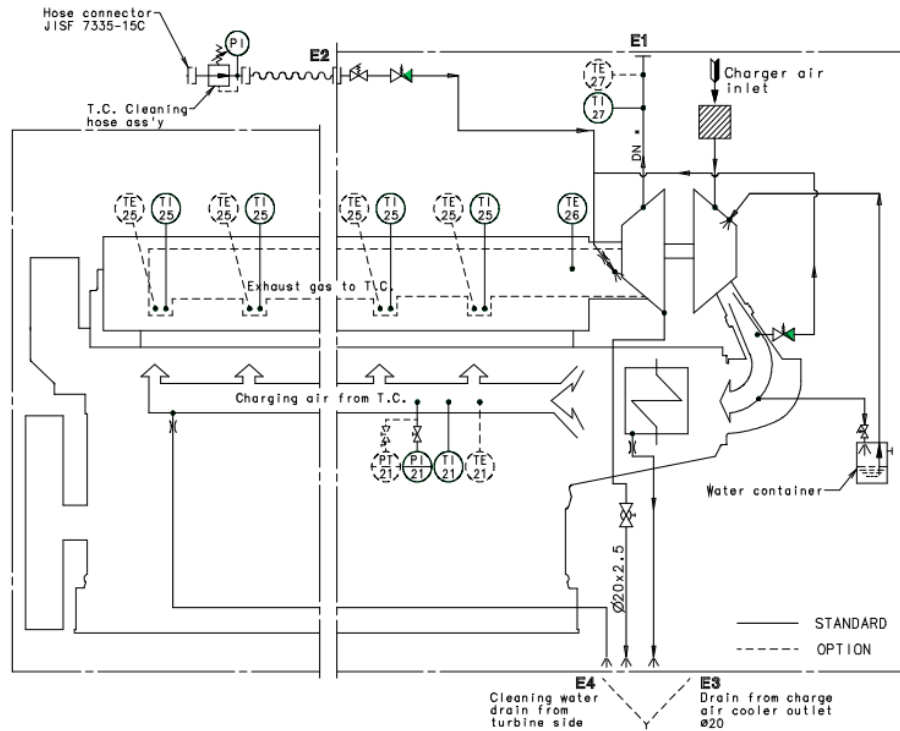

*) Scope of instrumentations will be according to extent of delivery and engine builder's standard.

Figure 9.3 Diagram for combustion and exhaust gas system

Table 9.4 Size of external pipe connection

Code.	Description	Size
E1	Exhaust gas outlet	-
E2	Water washing inlet for turbine	-
E3	Drain from charge air cooler outlet	Ø20
E4	Cleaning water drain from turbine	-

1. Connection size is according to JIS B 2220.

9.3.1 General description

The air required for combustion is taken from the engine room through a filter fitted on the turbocharger. It is imperative that the combustion air be free from sea water, dust and fumes etc.

Turbocharger

Turbocharger is a radial uncooled type with high efficiency and mounted on the free end of the engine block. The water washing systems for the compressor and turbine are supplied as standard.

Charge air cooler

Charge air cooler is one stage fresh water cooled type. In general, sea water cooled type charge air cooler is not recommended.

Water mist catcher

Water mist catcher is installed in the end part of charge air cooler.

Air chamber

Air chamber is incorporated into the engine block with large volume for even distribution of induced air to each cylinder.

Exhaust pipe system

Exhaust pipe system is a pulse type, which has better performance at low load with good acceleration. In this case, a jet air system may be required to improve acceleration.

Water drain pipes

Water drain pipes are installed for the air chamber and water mist catcher.

9.4 External combustion air system

9.4.1 General description

As the engines are consumed considerable amount of air in the engine room directly, or the outdoor intake air system is required, the design of combustion air is important not only for man-working but also for engine running.

Various requirements are applicable depending on the ambient condition but the minimum requirements and recommendations for the engines are described as follows.

9.4.2 Combustion air

Arrangement of intake air pipes should be made to supply fresh air for engine combustion, which should be free from any risk of water spray, exhaust gas, dust, oil mist and electric equipment, etc.

In case of the engine room intake air system, the intake air temperature of the engine room would be increased by the radiation heat from the engines and generators. Therefore intake air ducts should be installed to face the air intake silencer for each turbocharger as close as possible.

In case of the outdoor direct intake air system, the independent intake air system should be applied for each turbocharger even for the case of engine with two or more turbochargers. A different intake air design for the engine of each project, please contact to HHI-EMD. The piping system of intake air should be considered to allow thermal expansion and harmful vibration to avoid stress of pipe. The end of deep slope position of intake air pipe, cleanable waste trap and water drain should be prepared.

Combustion air intake pipe system, the air velocity must not exceed 15 m/s during engine running. Prior to commissioning, the pressure loss must be checked at compressor side whether the depression of compressor air inlet must not exceed 200 mmWC as maximum. The measuring point is approx. 1 ~ 2 m before from the turbocharger air inlet casing.

Air consumption volume should be designed in accordance with '3.2 engine capacity data'.

Air filtration should be prevented from the outdoor's sand, cement, dust, and other particles. All particles size are not to be entered maximum 5 µm and above.

Oil bath type filter are generally used for the industrial area, cement plants, and sand winded area. Recommendable pressure loss of oil bath intake filter is 50 ~ 70 mmWC and even of fouled condition, it must be kept within 110 mmWC.

Environmental condition of maximum particle size of dust is typically applied depending on site.

- ✓ Non-industrial area in rain / dry condition : 0.8 / 2 µm
- ✓ Area of emissions, chimneys, work area : 60 µm
- ✓ Metropolitan area , residential / Industrial area : 7 / 20 µm
- ✓ Desert area, during sand storms : 500 µm

Ventilation of engine room

To determine the amount of air ventilation for an engine room, all heat sources of the engine room should be considered.

Total amount of ventilation of auxiliary engine = $Q_c + Q_r + Q_v$ (m³/h)

Where :

Q_c (m³/h) : Air required for engine combustion,

$$Q_r = \frac{\text{Engine radiation heat (kJ/h)}}{\text{Air conditioning factor (} Q_a = 12 \text{)}}$$

Q_v (m³/h) : Air required for other heat sources such as alternator and exhaust gas pipe , etc.

1. Should outdoor intake air system, and shut-off of air intake be necessary, a special provision is required as option.

9.5 External exhaust gas system

9.5.1 General description

Exhaust gas of the engine flows out from turbocharger to atmosphere via an external exhaust gas system, which may be comprised of expansion bellows, exhaust gas pipe, exhaust gas boiler (possibly) and silencer, exhaust gas ventilation unit, relief valve (or rupture disc), etc.

Independent exhaust gas system

Independent exhaust gas system should be prepared for each engine even for the case of common boiler system with other engines. In case of applied two or more turbochargers on a single engine, the exhaust gas pipes are recommended to be combined into a Y-type forked pipe. And each exhaust gas pipe have to be symmetric and each exhaust gas flow should be no interference.

Exhaust gas back pressure

Back pressure of the exhaust system in total is recommended to be less than 300 mmWC at maximum countious rating. The maximum back pressure should not exceed 500 mmWC at maximum countious rating. Please see the '3.6 correction of fuel oil consumption' for the fuel consumption correction in case of exceeding 300 mmWC at maximum countious rating. The measuring position is approx. 1 ~ 2 m after the turbocharger gas outlet casing.

9.5.2 Velocity

External exhaust gas piping is recommended to be designed that velocity of exhaust gas through pipes should not exceed approximately 40 m/sec at maximum continuous rating.

Insulation

Insulation of the whole exhaust system is required for the safety and to reduce noise and loss of thermal energy, which, of course, should comply with requirements of classification society and other related authorities.

9.5.3 Piping design for exhaust gas system

In order to have lower back pressure and thermal loss, following design consideration is required ;

- ✓ Pipe should be as short and straight as possible. Pipe bendings should be minimized and the bending radius should be as large as possible.
- ✓ A water separating pocket and drain should be provided on the pipe.
- ✓ Rigid (fixed) supports and movable supports must be provided considering the thermal expansion and vibration of pipes.
- ✓ The exhaust gas outlet of Turbocharger can be turned on request.

For more information, please refer to the sheet '9.6 external exhaust gas pipe connection'.

9.5.4 Expansion bellows

The expansion bellows has to be mounted between the turbocharger outlet and external exhaust gas pipe in order to compensate thermal expansion and mechanical vibration. The expansion bellows are supplied separately as standard. However, an additional expansion bellows may be required depending on the actual length of exhaust pipe in total.

1. The external exhaust pipe must not exert any force against the gas outlet on the engine.
2. The external exhaust pipe just on expansion bellows should be fixed rigidly so that turbocharger can be free from any forces from the external exhaust pipe.
3. The sturdy fixed-point support must be provided for the expansion bellows on the turbocharger. It should be positioned, immediately above the expansion bellows in order to prevent the transmission of forces, resulting from the weight, thermal expansion or lateral displacement of the exhaust piping, to the turbocharger.
4. The exhaust piping should be mounted with a slope towards the gas outlet on the engine. It is recommended to have drain facilities in order to be able to remove condensate or rainwater.

Installation procedure for expansion bellow

- ✓ The generating set (or engine) should be installed in its final position before any external pipes are connected.
- ✓ Remove the counter flange from the engine connection, if fitted.
- ✓ Fasten the counter flange temporarily to the outlet side of the bellows. For the correct orientation of the bellows (flow direction), see the dimensional drawing.
- ✓ Fasten the bellows to the engine temporarily.
- ✓ Align the external pipe to the counter flange. No axial, lateral or angular deflection of the bellows is allowed. Anchor the external pipe to the steel structure within 1 m from flange. Observe that the pipe clamping with bracket must be very rigid in order to prevent vibration and movement of the exhaust gas pipe. Most problems with bursting and vibration originate from poor clamping and support. Especially the support in the axial direction must be rigid.
- ✓ Put some temporary protection cover between the flanges in order to prevent debris from falling into the turbocharger.
- ✓ Tack weld the counter flange to the external pipe.
- ✓ Remove the bellows and weld the flange finally to the external pipe.
- ✓ Remove the protection cover. Place the bellows with gaskets between the flanges.
- ✓ Lubricate the threads of the connection screw with heat resistant grease and tighten first until finger tight. Finally tighten the screw in a diagonal sequence.
- ✓ Remove the guide bar between the flanges of the bellows.

9.5.5 Exhaust gas boiler

Thermal energy of exhaust gas can be utilized by boiler. Please refer to the sheets '3.2 engine capacity data' for the exhaust gas data. A boiler may be a separate unit for each engine or a common unit with other engines. In any cases, however, the exhaust gas line for each engine should be separated from other engine's exhaust gas lines.

The back-pressure through boiler should be minimized to be within limited level for total exhaust gas system.

9.5.6 Exhaust gas silencer

Exhaust gas silencer can be supplied as option on request. The noise attenuation of silencer shall be either 25 dB(A) or 35 dB(A). For more information, please refer to the sheets for '9.8 exhaust gas silencer with spark arrestor' and '9.9 exhaust gas silencer without spark arrestor'.

9.6 External exhaust gas pipe connection

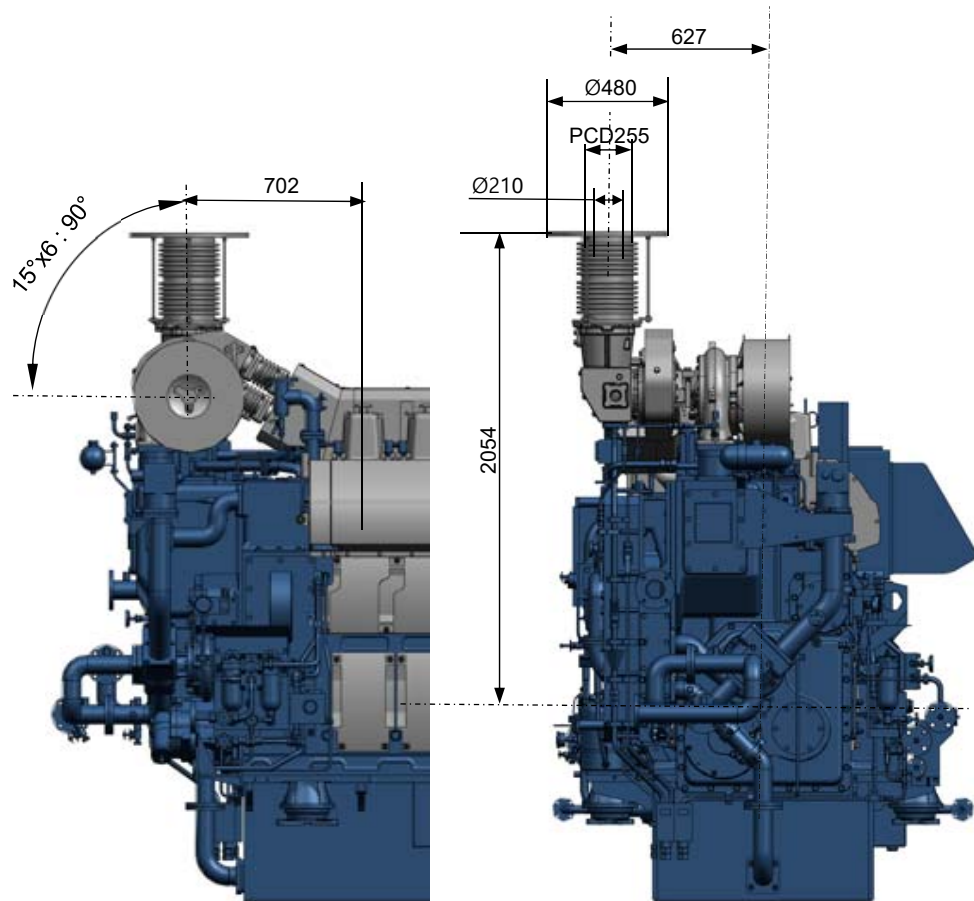

Figure 9.4 External exhaust gas pipe connection.

9.7 Approach of SCR (Selective Catalytic Reduction) system installation

9.7.1 General description

IMO NOx Tier III regulation was in effect from the year 2016 according to IMO's environmental policy, in which NOx emission should be reduced by 80 % level comparing to the IMO NOx Tier I. SCR (Selective Catalytic Reduction) system became one of proper solutions to meet the IMO NOx Tier III regulation.

The HiMSEN engine is able to be combined SCR (Selective Catalytic Reduction) systems provided by third parties. However, HHI-EMD recommends using Hyundai NoNOx SCR (Selective Catalytic Reduction) system for convenience such as testing NOx Scheme A test for EIAPP certificate and providing integrated technology. For detailed specifications of Hyundai NoNOx, please see the HYUNDAI HiMSEN ENGINE programme or contact to HHI-EMD.

9.7.2 Boundary conditions for SCR (Selective Catalytic Reduction) operation

General boundary conditions for SCR (Selective Catalytic Reduction) operation :

Main diesel fuel oil

- ✓ The diesel fuel for SCR (Selective Catalytic Reduction) operation should be selected according to the sulfur content in consideration of the sailing region and SCR (Selective Catalytic Reduction) specifications.

Exhaust gas temperature

- ✓ The minimum required temperature for SCR (Selective Catalytic Reduction) operation is determined by the sulfur content in fuel and SCR (Selective Catalytic Reduction) specifications.

Maximum exhaust gas back pressure

- ✓ Allowable back pressure in total of the exhaust system to guarantee fuel consumption see the sheet '9.5.1 General description'. It is not recommended that the exhaust gas's total back pressure exceeds 500 mm WC in diesel mode MCR (Maximum Countious Rating).

Other equipment installation such as exhaust gas boiler, silencer, etc. between the engine and the SCR chamber is not recommended in order to keep exhaust gas temperature.

9.7.3 Exceptionals

In exceptional cases of SCR (Selective Catalytic Reduction) installation, please contact to HHI-EMD.

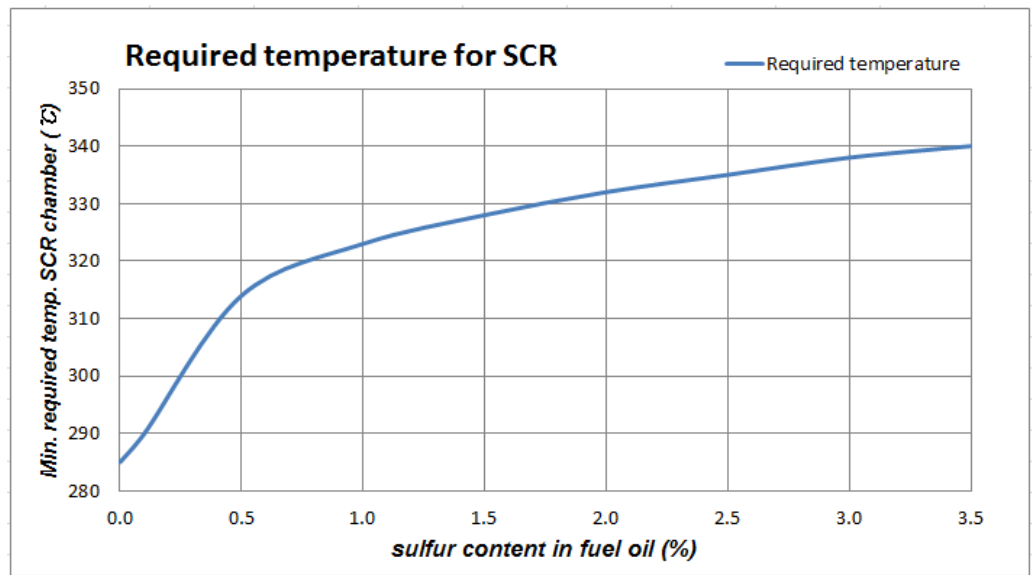

Figure 9.5 Minimum required exhaust gas temperature for SCR operation

1. When SCR (Selective Catalytic Reduction) units are installed, the heat loss of the exhaust gas pipe between engine and SCR (Selective Catalytic Reduction) chamber should be designed to be minimized in order to keep the required exhaust gas temperature. The supports of exhaust gas pipe should be designed and installed to minimize heat loss.

9.8 Exhaust gas silencer with spark arrestor

The silencer is of an absorption type delivered with spark arrestor and mounting bracket, excluding insulation. The silencer can be mounted horizontally or vertically.

The gas flow passes through a straight perforated tube, surrounded with an efficient sound absorbing material. The silencer gives whereby an excellent sound attenuation suitable for even a wide operating range.

The gas pressure will be dropped into an approximate value shown on the graph, pressure loss vs. gas velocity.

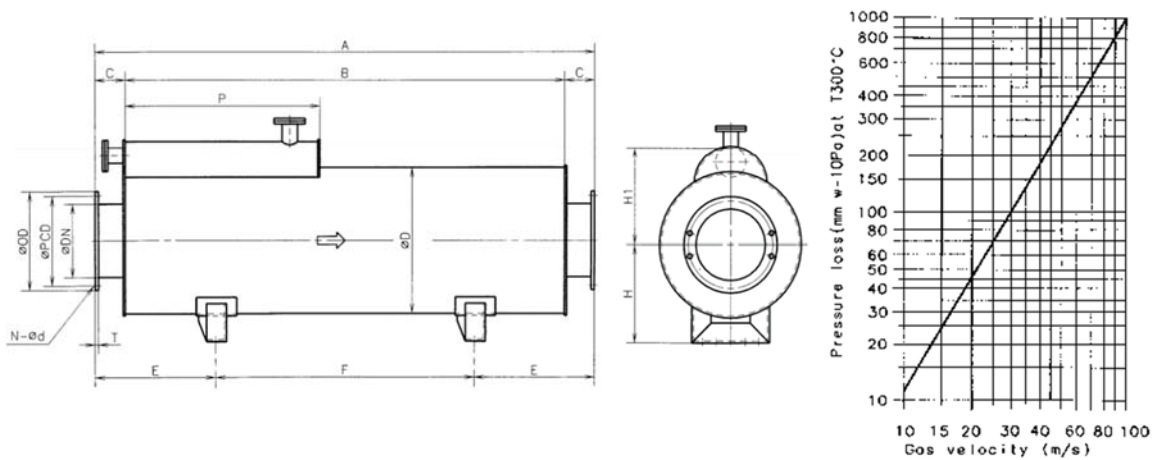

Figure 9.6 Exhaust gas silencer (25 dB type).

Table 9.5 Exhaust gas silencer size (25 dB type) (unit : mm)

Cylinder type	DN	A	B	C	D	E	F	
6 (900 rpm)	350	2850	2550	150	710	600	1650	
Cylinder type	H	H1	P	PCD	OD	T	N-d	Weight (kg)
6 (900 rpm)	500	485	970	435	480	16	12 - Ø25	510

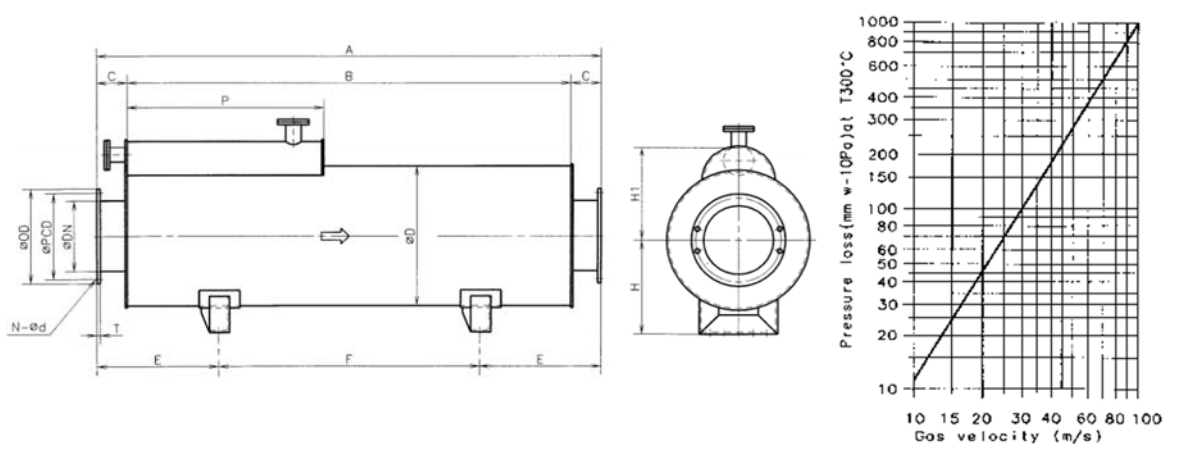

Figure 9.7 Exhaust gas silencer (35 dB type).

Table 9.6 Exhaust gas silencer size (35 dB type) (unit : mm)

Cylinder type	DN	A	B	C	D	E	F	
6 (900 rpm)	350	4000	3700	150	710	1000	2000	
Cylinder type	H	H1	P	PCD	OD	T	N-d	Weight (kg)
6 (900 rpm)	500	485	970	435	480	16	12 - Ø25	545

9.9 Exhaust gas silencer without spark arrestor

The silencer is of an absorption type delivered with mounting bracket, excluding the spark arrestor and insulation. The silencer can be mounted horizontally or vertically.

The gas flow passes through a straight perforated tube, surrounded with an efficient sound absorbing material. The silencer gives whereby an excellent sound attenuation suitable for even a wide operating range.

The gas pressure will be dropped into an approximate value shown on the graph, pressure loss vs. gas velocity.

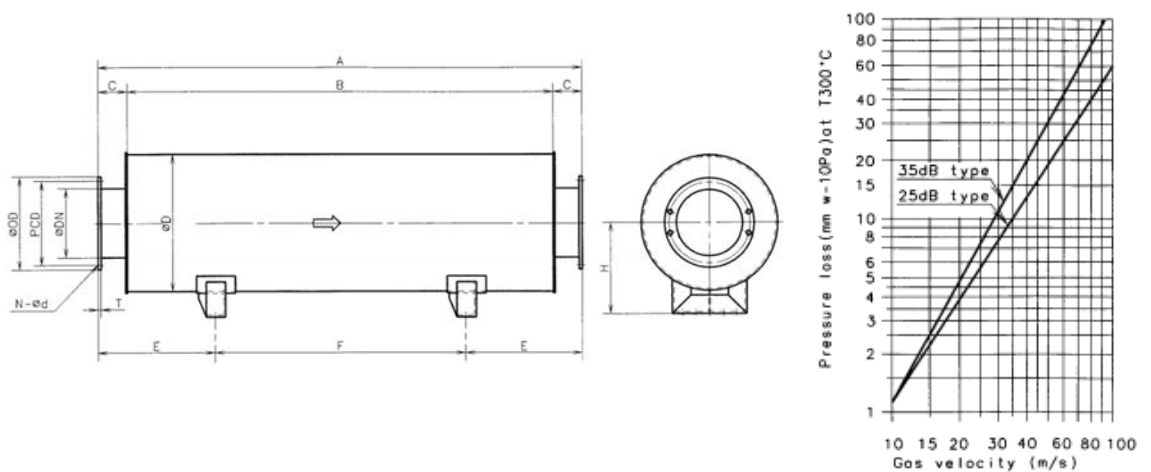

Figure 9.8 Exhaust gas silencer (25 dB type).

Table 9.7 Exhaust gas silencer size (25 dB type) (unit : mm)

Cylinder type	DN	A	B	C	D	E	F
6 (900 rpm)	350	2600	2300	150	710	600	1400
Cylinder type	H	PCD	OD	T	N-d	Weight (kg)	
6 (900 rpm)	500	435	480	16	12 - Ø25	430	

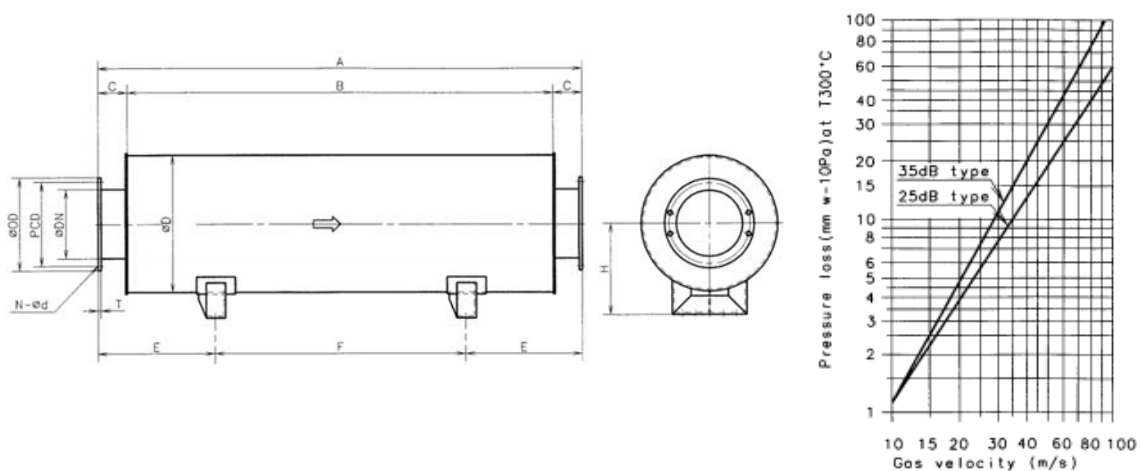

Figure 9.9 Exhaust gas silencer (35 dB type).

Table 9.8 Exhaust gas silencer size (35 dB type) (unit : mm)

Cylinder type	DN	A	B	C	D	E	F
6 (900 rpm)	350	3500	3200	150	700	850	1800
Cylinder type	H	PCD	OD	T	N-d	Weight (kg)	
6 (900 rpm)	500	435	480	16	12 - Ø25	490	

9.10 Generator information

Mounting of generator

As a standard design of H17/28E(U) engine, the engine and generator are directly coupled and resiliently mounted on common base frame.

Generator bearing

Type of generator bearing is of single sleeve, self-lubricating type and mounted end of generator.

Optional design

As special arrangement, double sleeve bearing, forced lubricating of generator bearing, cooler and flexible coupling can be applied as an optional design on request.

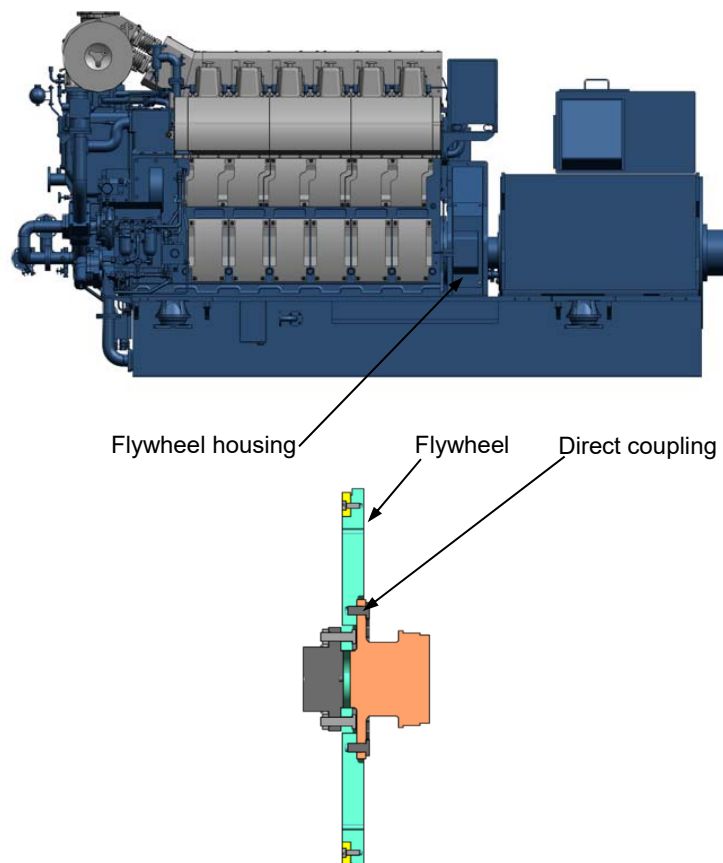

Figure 9.10 Direct coupling outline

This page is intentionally blanked

10 Engine maintenance

10.1 Maintenance schedule

Table 10.1 Maintenance guidance.

Section No.	Description	Overhaul interval (hours)											Remark
		Others	500 *)	2000	4000	8000	12000	16000	20000	24000	28000	32000	

Major fasteners - confirmation

M11100	S11100	Bolt for base frame and resilient mount		▲			◆								
G11100	-	Nut for resilient mount and foundation		▲			◆								
-	S13000	Bolt for engine block and base frame		◆			◆								
M13250	S13000	Hydraulic nut for main bearing cap		◆			◆								
M21100	S13000	Hydraulic nut for cylinder head		◆			◆								
M25000	S25000	Bolt and nut for camshaft		▲			◆								
M31000	S32000	Bolt for connecting rod (big-end)		◆			◆								■
M33200	S33100	Bolt for counter weight		◆			◆								
M35300	S35000	Bolt and nut for timing gear		▲			◆								
-	S81000	Bolt and nut for turbocharger mounting		▲			◆								

- Expected life time √ 1 Cylinder overhaul. If not good, check all cylinders.
- Overhaul inspection ◆ Confirm tightening: tighten with specified torque or hyd.pressure. Do not loosen!
- Check & adjustment ◎ Measuring or sampling without dismantling
- Function test ▲ Visual inspection

*) These are not parts of normal maintenance interval, but, the confirmation or visual inspection of the specified ones to be carried out after Overhaul / New.

1. When doing maintenance and overhaul work, seals (o-rings and gaskets, etc.) should be renewed.
2. The overhaul intervals and expected life time stated above are only for guidance as these depend on the actual service condition, the quality of used fuel or lubricating oil, the treatment of cooling water and so on.

Section No	Description	Overhaul interval (hours)											Remark
		Others	500 *)	2000	4000	8000	12000	16000	20000	24000	28000	32000	
Resilient mount													
M11100	S11100	Resilient mount	●				●						**)
Major bearing													
M13250	S13250	Main bearing					√				■		
M13250	S13250	Thrust washer : axial clearance					◎						■
M25000 M25300	S25300	Camshaft bearing : clearance					√		◎				■
M32120	S32000	Connecting rod bearing (big-end)					√		■		■		
M32130	S32000	Connecting rod bearing (small-end)					√		■				■
M35300	S35000	Bearing bush for Idle gear : clearance											■

■ Expected life time √ 1 Cylinder overhaul. If not good, check all cylinders.

■ Overhaul inspection ◆ Confirm tightening: tighten with specified torque or hyd.pressure. Do not loosen!

● Check & adjustment ◎ Measuring or sampling without dismantling

○ Function test ▲ Visual inspection

*) These are not parts of normal maintenance interval, but, the confirmation or visual inspection of the specified ones to be carried out after Overhaul / New.

**) During on board (site) commissioning, inspection is carried out by HHI-EMD service engineer.

1. When doing maintenance and overhaul work, seals (o-rings and gaskets, etc.) should be renewed.
2. The overhaul intervals and expected life time stated above are only for guidance as these depend on the actual service condition, the quality of used fuel or lubricating oil, the treatment of cooling water and so on.

Section No	Description	Overhaul interval (hours)											Remark
		Others	500 *)	2000	4000	8000	12000	16000	20000	24000	28000	32000	

Cylinder unit and connecting rod

M15100	S15000	Cylinder liner					√		■						
M15100	S15000	Flame ring					√		▣						
M21100	S15000 S21100	Cylinder head and water jacket cooling water space					√		■						
M21120 M21130 M21200	S21100 S21200	Intake/exhaust valve spindle, seat ring and valve guide : overhaul and reconditioning					√		■		▣				
M21210	S21200	Intake/exhaust valve : clearance		●	●										**)
M21210	S21200	Rocker arm shaft and bush					√		■						
M21220	S21200	Rotocap			○				■						
	S22000	Indicator valve							▣						
M31100	S31100	Piston rings					√		▣						
M31100	S31100	Piston and piston pin					√		■						
M31100 M31101	S32000	Connecting rod bore (big-end)					√		■						
M31100 M32130	S32000	Piston pin and connecting rod (small-end) : clearance					√		■						
	S32000	Bolt for connecting rod													▣

- ▣ Expected life time √ 1 Cylinder overhaul. If not good, check all cylinders.
- Overhaul inspection ◆ Confirm tightening: tighten with specified torque or hyd.pressure. Do not loosen!
- Check & adjustment ◎ Measuring or sampling without dismantling
- Function test ▲ Visual inspection

*) These are not parts of normal maintenance interval, but, the confirmation or visual inspection of the specified ones to be carried out after Overhaul / New.
 **) During on board (site) commissioning, inspection is carried out by HHI-EMD service engineer.

1. When doing maintenance and overhaul work, seals (o-rings and gaskets, etc.) should be renewed.
2. The overhaul intervals and expected life time stated above are only for guidance as these depend on the actual service condition, the quality of used fuel or lubricating oil, the treatment of cooling water and so on.

Section No	Description	Overhaul interval (hours)											Remark
		Others	500 *)	2000	4000	8000	12000	16000	20000	24000	28000	32000	

Crankshaft and gears

-	S33500	Flexible coupling (If applied)	▲											***)
M35300	S35000	Timing gear and pump driving gear : clearance and backlash							◎					
M33100	S33100	Crankshaft : deflection					◎							
-	S33300 S42300	Gear teeth on flywheel and turning gear					▲							
-	S33400	Torsional vibration damper : fluid sampling (only for viscous damper)							◎					***)

Valve operating mechanism

M23000	S23000	Swing arm roller shaft and bush							■					■
M25000	S23000 S25000	Contact faces of cam and swing arm roller camshaft bearing		▲			▲							

- ▣ Expected life time √ 1 Cylinder overhaul. If not good, check all cylinders.
- Overhaul inspection ◆ Confirm tightening: tighten with specified torque or hyd.pressure. Do not loosen!
- Check & adjustment ◎ Measuring or sampling without dismantling
- Function test ▲ Visual inspection

*) These are not parts of normal maintenance interval, but, the confirmation or visual inspection of the specified ones to be carried out after Overhaul / New.

***) See maker manual recommendation.

1. When doing maintenance and overhaul work, seals (o-rings and gaskets, etc.) should be renewed.
2. The overhaul intervals and expected life time stated above are only for guidance as these depend on the actual service condition, the quality of used fuel or lubricating oil, the treatment of cooling water and so on.

Section No	Description	Overhaul interval (hours)											Remark
		Others	500 *)	2000	4000	8000	12000	16000	20000	24000	28000	32000	

Control system

G40000	S41000	Fuel control linkage : movement check	○													Weekly
G40001	-	Safety device : function check	○													Monthly
-	S41000	Governor oil level (only for mechanical hydraulic governor)	▲													***) Daily
M45200	S45200	Engine RPM pick-up sensor : clearance					●									
M45200	S45200	Temperature / pressure sensor	○													In case of necessity

- ▣ Expected life time √ 1 Cylinder overhaul. If not good, check all cylinders.
- Overhaul inspection ◆ Confirm tightening: tighten with specified torque or hyd.pressure. Do not loosen!
- Check & adjustment ◎ Measuring or sampling without dismantling
- Function test ▲ Visual inspection

*) These are not parts of normal maintenance interval, but, the confirmation or visual inspection of the specified ones to be carried out after Overhaul / New.

***) See maker manual recommendation.

1. When doing maintenance and overhaul work, seals (o-rings and gaskets, etc.) should be renewed.
2. The overhaul intervals and expected life time stated above are only for guidance as these depend on the actual service condition, the quality of used fuel or lubricating oil, the treatment of cooling water and so on.

Section No.	Description	Overhaul interval (hours)											Remark	
		Others	500 ^{*)}	2000	4000	8000	12000	16000	20000	24000	28000	32000		
Fuel system														
G05100	-	Analyze fuel oil properties : sampling	⊙											Every bunkering
M51100	S51000	Fuel injection pump												
		Deflector : erosion				⊙	■							
		Plunger assembly				■								■
		Delivery valve assembly (except case)				■		■						
		Delivery valve case				■								■
		Roller bush for tappet						■						■
M52000 M52002 M52003	S52000	Fuel injection valve : opening pressure		●	●	■							****) ■ : Atomizer life time	
M98380	S98380	Fuel oil shock absorber(If applied)				■								
M56000	S56001	Fuel oil filter	■										If pressure drop reaches limit (See G01400)	

- Expected life time √ 1 Cylinder overhaul. If not good, check all cylinders.
- Overhaul inspection ◆ Confirm tightening: tighten with specified torque or hyd.pressure. Do not loosen!
- Check & adjustment ⊙ Measuring or sampling without dismantling
- Function test ▲ Visual inspection

*) These are not parts of normal maintenance interval, but, the confirmation or visual inspection of the specified ones to be carried out after Overhaul / New.

****) Regardless of the normal check and adjustment interval, if the exhaust gas temperature deviation alarm occurs, individual cylinders should be inspected according to M52000.

1. When doing maintenance and overhaul work, seals (o-rings and gaskets, etc.) should be renewed.
2. The overhaul intervals and expected life time stated above are only for guidance as these depend on the actual service condition, the quality of used fuel or lubricating oil, the treatment of cooling water and so on.

Section No.	Description	Overhaul interval (hours)											Remark
		Others	500 *)	2000	4000	8000	12000	16000	20000	24000	28000	32000	

Lubricating oil system

G06200	-	Analyze lubricating oil properties : sampling	◎												Every 3 month
M61000	S61000	Lubricating oil pump						■							
M62000	S62000	Lubricating oil cooler	■												***)
M63000	S63000	Lubricating oil filter (cartridge type)	■	▣											If pressure drop reaches limit (See G01400)
-	S63000	Auto backwashing filter (If applied)	■												***)
-	S64000	Thermostatic valve : clean and check the elements						■							***)
M67000	S67000	Lubricating oil centrifugal filter	■												***)

Cooling water system

G07100	-	Analyze cooling water properties : sampling	◎												Weekly : test kit Every 3 month : lab. test
M71000	S71000	Cooling water pump						■							
-	S74000	Thermostatic valve : clean and check the elements						■							***)
M75000	S75000	Water drain line : cleaning	●												Weekly(depend on condition)

▣ Expected life time √ 1 Cylinder overhaul. If not good, check all cylinders.

■ Overhaul inspection ◆ Confirm tightening: tighten with specified torque or hyd.pressure. Do not loosen!

● Check & adjustment ◎ Measuring or sampling without dismantling

○ Function test ▲ Visual inspection

*) These are not parts of normal maintenance interval, but, the confirmation or visual inspection of the specified ones to be carried out after Overhaul / New.

***) See maker manual recommendation.

1. When doing maintenance and overhaul work, seals (o-rings and gaskets, etc.) should be renewed.

2. The overhaul intervals and expected life time stated above are only for guidance as these depend on the actual service condition, the quality of used fuel or lubricating oil, the treatment of cooling water and so on.

Section No.	Description	Overhaul interval (hours)											Remark
		Others	500 ^{*)}	2000	4000	8000	12000	16000	20000	24000	28000	32000	

Compressed air system

O02300	-	Air running	○											Monthly
G40000	-	Check starting and stop system	○											Weekly (over a week stand-still condition)
	S42100	Starting air motor	■											***)

Combustion air system

G81000	AC75000	Charge air condensate drain pipe	●											Weekly
M80000	S83000	Turbocharger	■											***)
		Clean air filter (only for filter silencer type)	■	■										Every 500 hours running
		Turbine : water-washing	●											Every 200 hours running
		Compressor : water-washing	●											Every 24 ~ 50 hours running
M84000	S84000	Charge air cooler								■				

- Expected life time √ 1 Cylinder overhaul. If not good, check all cylinders.
- Overhaul inspection ◆ Confirm tightening: tighten with specified torque or hyd.pressure. Do not loosen!
- Check & adjustment ◎ Measuring or sampling without dismantling
- Function test ▲ Visual inspection

*) These are not parts of normal maintenance interval, but, the confirmation or visual inspection of the specified ones to be carried out after Overhaul / New.

***) See maker manual recommendation.

1. When doing maintenance and overhaul work, seals (o-rings and gaskets, etc.) should be renewed.
2. The overhaul intervals and expected life time stated above are only for guidance as these depend on the actual service condition, the quality of used fuel or lubricating oil, the treatment of cooling water and so on.

10.2 Recommended wearing parts

List of consumable parts for one engine (C=Number of cylinder / U=Number of unit)

Table 10.2 List of consumable parts for one engine

Section No.	Parts description	Quantity for the operating hours								
		set/ea	0 – 4000	0 – 8000	0 – 12000	0 – 16000	0 – 20000	0 – 24000	0 – 28000	0 – 32000

Covers for engine block

S19300	Gaskets for gear case cover	set	-	1	1	2	2	3	3	4
S19300	O-ring for crankcase cover	ea	-	2 x C	2 x C	4 x C	4 x C	6 x C	6 x C	8 x C
S19300	O-ring for camshaft cover	set	-	0.5 x C	0.5 x C	1 x C	1 x C	1.5 x C	1.5 x C	2 x C
S21100	O-ring for cylinder head cover	ea	0.5 x C	1 x C	1.5 x C	2 x C	2.5 x C	3 x C	3.5 x C	4 x C

Bearings

S13250	Main bearing (upper and lower)	set	-	-	-	-	-	1xC+ 1	1xC+ 1	1xC+ 1
S13250	Thrust washer	ea	-	-	-	-	-	-	-	2
S25300	Camshaft bearing	ea	-	-	-	-	-	-	-	1xC+ 2
S32000	Big-end bearing (upper and lower)	set	-	-	-	-	-	1 x C	1 x C	1 x C
S32000	Small-end bearing	ea	-	-	-	-	-	-	-	1 x C
S35000	Bearing bush for idle gear	ea	-	-	-	-	-	-	-	1

Cylinder unit and connecting rod

S15000	Flame ring	ea	-	-	-	1 x C	1 x C	1 x C	1 x C	2 x C
S15000	O-rings and gasket for cylinder liner / cooling water jacket	set	-	1	1	1xC+ 1	1xC+ 1	2xC+ 1	2xC+ 1	3xC+ 1
S21100	O-rings for cylinder head	ea	-	1	1	1xC+ 1	1xC+ 1	2xC+ 1	2xC+ 1	3xC+ 1

1. The list of consumable parts stated above is only for guidance as this depends on the actual service condition, the quality of used fuel or lubricating oil, the treatment of cooling water and so on.

Section No.	Parts description	Quantity for the operating hours								
		Set/ea	0 – 4000	0 – 8000	0 – 12000	0 – 16000	0 – 20000	0 – 24000	0 – 28000	0 – 32000

Cylinder unit and connecting rod

S21100	Bush and O-ring for fuel valve	set	-	-	-	1 x C	1 x C	1 x C	1 x C	2 x C
S21100	O-rings for valve guide and exhaust valve seat ring	set	-	-	-	1 x C	1 x C	2 x C	2 x C	3 x C
S21100 S21200	Intake valve spindle, seat ring and valve guide	set	-	-	-	-	-	1 x C	1 x C	1 x C
S21100 S21200	Exhaust valve spindle, seat ring and valve guide	set	-	-	-	-	-	1 x C	1 x C	1 x C
S22000	Indicator valve complete	set	-	-	-	1 x C	1 x C	1 x C	1 x C	2 x C
S23000	O-rings for push rod cover	ea		1	1	1xC+ 1	1xC+ 1	2xC+ 1	2xC+ 1	3xC+ 1
S23000	Roller bush for swing arm	ea	-	-	-	-	-	-	-	1 x C
S31100	Piston ring-top ring / 2nd ring / scraper ring	set	-	-	-	1 x C	1 x C	1 x C	1 x C	2 x C
S32000	Bolt for connecting rod shaft	ea	-	-	-	-	-	-	-	2 x C

Fuel system

S51000	Plunger assembly for fuel pump	ea	-	-	-	-	-	-	-	1 x C
S51000	O-rings and seal ring for plunger assembly	set	-	1 x C	1 x C	2 x C	2 x C	3 x C	3 x C	4 x C
S51000	Deflector and gasket for fuel pump	set	-	1 x C	1 x C	2 x C	2 x C	3 x C	3 x C	4 x C
S51000	Delivery valve assembly (except case)	set	-	-	-	1 x C	1 x C	1 x C	1 x C	2 x C
S51000	Delivery valve case	ea	-	-	-	-	-	-	-	1 x C
S51000	O-ring for fuel pump	set	-	1 x C	1 x C	2 x C	2 x C	3 x C	3 x C	4 x C
S51000	Roller bush for tappet	ea								1 x C
S51000	O-ring for fuel pump drive	ea	-	-	-	-	-	-	-	1 x C
S52000	Fuel injection nozzle with dowel pin	set	-	1 x C	1 x C	2 x C	2 x C	3 x C	3 x C	4 x C

1. The list of consumable parts stated above is only for guidance as this depends on the actual service condition, the quality of used fuel or lubricating oil, the treatment of cooling water and so on.

Section No.	Parts description	Quantity for the operating hours								
		Set/ea	0 – 4000	0 – 8000	0 – 12000	0 – 16000	0 – 20000	0 – 24000	0 – 28000	0 – 32000

Fuel system

S52000	O-rings and gasket for fuel injection valve	set	2 x C	4 x C	6 x C	8 x C	10 x C	12 x C	14 x C	16 x C
S52300	O-rings for fuel injection pipe block	set	2 x C	4 x C	6 x C	8 x C	10 x C	12 x C	14 x C	16 x C

Lubricating oil System

S61000	Bushes for lubricating oil pump	set	-	-	-	1 x U	1 x U	1 x U	1 x U	2 x U
S61000	O-rings for lubricating oil pump	set	-	-	-	1 x U	1 x U	1 x U	1 x U	2 x U
S63000	Lubricating oil filter cartridge (paper cartridge type)	ea	2 x U	4 x U	6 x U	8 x U	10 x U	12 x U	14 x U	16 x U
S63000	O-rings for lubricating oil filter assembly (paper cartridge type)	set	1 x U	2 x U	3 x U	4 x U	5 x U	6 x U	7 x U	8 x U
S67000	Spare parts for centrifugal filter (See manual for centrifugal filter)	set	-	-	-	-	-	-	-	-

Cooling water system

S71000	Oil seal, mechanical seal and O-ring for high and low temperature cooling water pump	set	-	-	-	1 x U	1 x U	1 x U	1 x U	2 x U
--------	--	-----	---	---	---	-------	-------	-------	-------	-------

Supercharging system

S81000	Gaskets and O-ring for compressor out	set	-	-	-	1	1	1	1	2
S82000	Gasket for connection flange	ea	-	1	1	1xC+1	1xC+1	2xC+1	2xC+1	3xC+1
S83000	O-rings and gaskets for Turbocharger connection	set	-	-	-	1	1	1	1	2

Charge air cooler

S84000	O-rings and gaskets for air cooler	set	-	-	-	1	1	1	1	2
--------	------------------------------------	-----	---	---	---	---	---	---	---	---

1. The list of consumable parts stated above is only for guidance as this depends on the actual service condition, the quality of used fuel or lubricating oil, the treatment of cooling water and so on.

Section No.	Parts description	Quantity for the operating hours								
		Set/ea	0 – 4000	0 – 8000	0 – 12000	0 – 16000	0 – 20000	0 – 24000	0 – 28000	0 – 32000

Turbocharger

	Turbine nozzle ring (See manual for turbocharger)	ea	-	-	-	1	1	1	1	2
	Spare parts for turbocharger (See manual for turbocharger)	set	-	-	-	-	-	-	-	-
	Air filter mat (Engine room air suction)	ea	2	4	6	8	10	12	14	16

1. The list of consumable parts stated above is only for guidance as this depends on the actual service condition, the quality of used fuel or lubricating oil, the treatment of cooling water and so on.

10.3 List of standard spare parts

List of minimum spare parts for each plant or each ship (valid for all classification societies)

Table 10.3 List of standard spare parts

Parts description	Q'ty	Section No.	Item No.	Remark
Engine block and covers				
Main bearing	1	S13250	251	
Thrust washer	2	S13250	252	
Main bearing stud	2	S13000	231	
Nut for main bearing stud	2	S13000	232	
O-ring for crankcase door	1	S19300	380	
Cylinder head and cylinder liner				
Valve spindle, inlet	2	S21200	201	
Valve spindle, exhaust	4	S21200	202	
Conical piece	6	S21200	206	
Valve spring	6	S21200	203	
Valve seat, inlet	2	S21100	111	
Valve seat, exhaust	4	S21100	112	
Valve rotator	6	S21200	204	
O-ring for cylinder head	2	S21100	903	
O-ring for cylinder head cover	1	S21100	135	
O-ring for cooling water connection	2	S15000	903	
O-ring for compressed air connection	1	S15000	902	
O-ring for cooling water jacket, D38	2	S15000	905	

Parts description	Q'ty	Section No.	Item No.	Remark
Cylinder head and cylinder liner				
O-ring for cylinder liner	1	S15000	500	
O-ring for cylinder liner	1	S15000	901	
O-ring for cylinder liner	1	S15000	904	
Sealing ring for cylinder liner	1	S15000	112	
Piston and connecting rod				
Piston pin	1	S31100	120	
Piston ring, top	1	S31100	151	
Piston ring, 2nd	1	S31100	152	
Piston ring, scraper	1	S31100	153	
Connecting rod bearing	1	S32100	120	
Bush for connecting rod	1	S32100	130	
Connecting rod big end stud, M24	2	S32100	191	
Fuel injection equipment				
Fuel injection pump	1	S51000	100	
Fuel injection valve	N	S52000	100	N : half of maximum. cylinder No.
Fuel high pressure block	1	S52300	100	
Piping system				
Flexible connecting pipe, each type	1 set	S98370	-	
Lube oil filter cartridge	1 set	S63000	202	
Shaft seal for pre-lubricating pump	1	S65000	206	

10.4 Heavy parts for maintenance

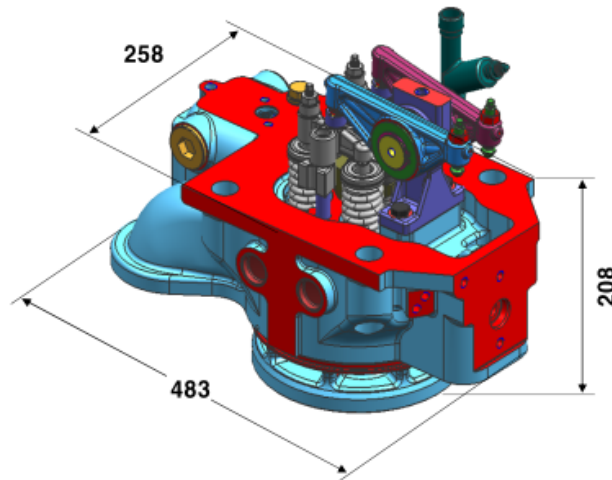

Cylinder head and rocker arms assembly
Approx. 75 kg

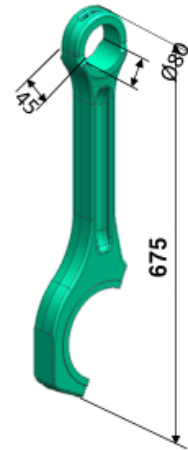

Connecting rod shaft
Approx. 14.1 kg



Cylinder liner
Approx. 33 kg



Piston
Approx. 9.5 kg

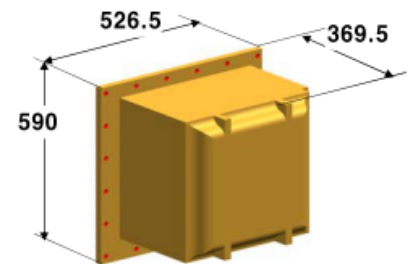

Air Cooler
Approx. 160 kg

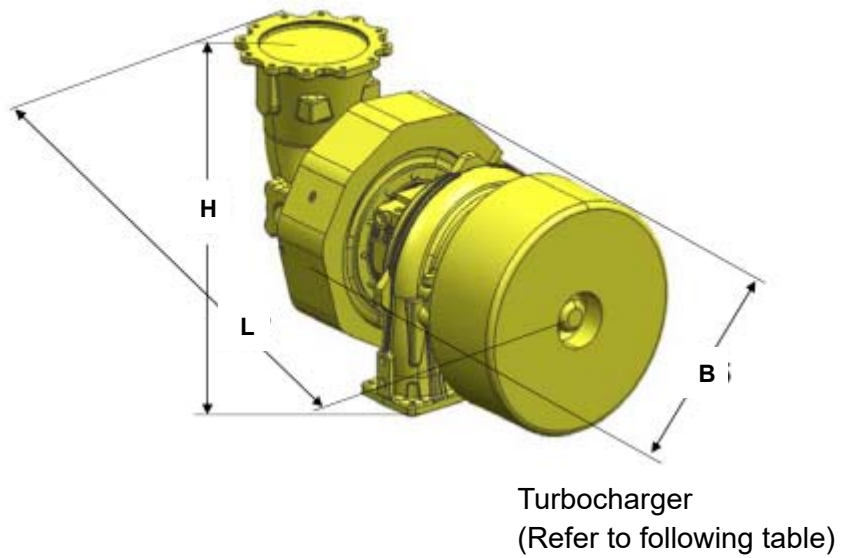

Figure 10.1 Heavy parts dimension and weight.

Table 10.4 List of turbocharger outline dimension and weight

Turbocharger type	B	H	L	Weight (kg)	Remarks
HPR3000, ST3	425	449	930	135	Without insulation
TPS48, A130	448	511	926	129	Without insulation

10.5 List of standard tools

Table 10.5 List of standard tool parts































Tool description	Q'ty	Remark
Cylinder head and liner		
Lifting tool for cylinder unit	1	
Fitting/removal device for valve cone/spring	1	
Removal device for fuel injection valve	1	
Grinding tool for cylinder head and cylinder liner	1	
Extract/suspension device for cylinder liner	1	
Cylinder bore gauge	1	
Removing device for flame ring	1	
Feeler gauge for inlet and exhaust valve.	1	
Removal tool locking ring	1	
Removal device for exhaust valve seat	1	
Lapping device for inlet / exhaust valve seat	1	
Piston and connecting rod		
Guide for piston	1	
Lifting jig for piston	1	
Plier for piston pin lock ring	1	
Piston ring opener	1	
Crankshaft and main bearing		
Lifting device for main bearing	4	
Fitting device for main bearing	1	
Deflection gauge for crankshaft	1	

Tool description	Q'ty	Remark
Fuel injection valve		
Test tool for fuel valve nozzle	1	
Lapping device for fuel injection valve bush	1	
Socket for nozzle	1	
Cleaning tool for fuel valve nozzle	1	
Removal device for fuel valve bush	1	
Nozzle removing tool	1	
General tools		
Max. pressure indicator	1	
Turning bar	t	
Extension bar	1	
Spanner plate	1	
Engine cleaner	1	
Hydraulic tools		
Hydraulic tightening devices M24	4	
Set of spare parts for hydraulic tools M24	1	
Support for hydraulic tools M24 (main bearing)	2	
Support for hydraulic tools M24 (cylinder head)	4	
Extension screw for hydraulic tools M24 (cylinder head)	4	
Distribution pieces 2-POT	1	
Distribution pieces 4-POT	1	
High pressure hose (L=550)	4	
High pressure hose (L=3000)	1	

Tool description	Q'ty	Remark
Hydraulic tools		
Adapter for hydraulic hand pump	1	
Hydraulic hand pump	1	
Turning pin (Ø10)	2	
Turning pin (Ø8)	2	
Standard tool box		
Tool box	1	

















This page is intentionally blanked

11 Appendix 1 (Piping symbols)

























No.	Symbol	Symbol designation	No.	Symbol	Symbol designation
General conventional symbols					
1.1		Pipe	1.5		Indicating and measuring instruments
1.2		Pipe with indication of direction of flow	1.6		High pressure pipe
1.3		Valves, gate valves, cocks and flaps	1.7		Tracing
1.4		Appliances	1.8		Enclosure for several components assembled in one unit
Pipes and pipe joint					
2.1		Crossing pipes, not connected	2.13		Blank flange
2.2		Crossing pipes, connected	2.14		Spectacle flange
2.3		Tee pipe	2.15		Bulkhead fitting water tight, flanged
2.4		Flexible pipe	2.16		Bulkhead crossing, non-water tight
2.5		Expansion pipe	2.17		Test piece with plug
2.6		Joint, Screwed	2.18		Orifice
2.7		Joint, flanged	2.19		Reducer
2.8		Joint, sleeve	2.20		Open drain and air vent
2.9		Joint, hose coupling	2.21		Orifice
2.10		Expansion joint with gland	2.22		Loop expansion joint
2.11		Expansion pipe	2.23		Snap-coupling
2.12		Cap nut			



No.	Symbol	Symbol designation	No.	Symbol	Symbol designation
Valves, gate valves, cocks and flaps					
3.1		Valve, straight	3.24		Suction valve chest with non-return valves
3.2		Valve, angle	3.25		Double-seated changeover valve, straight
3.3		Stop valve (Screw ended)	3.26		Double-seated changeover valve, angle
3.4		Valve, Three-way	3.27		Cock, straight through
3.5		Non-return valve (Flap) straight	3.28		Cock, angle
3.6		Non-return valve (Flap) angle	3.29		Cock, three-way, L-port in plug
3.7		Non-return valve (Flap) straight, screw down	3.30		Cock, three-way, T-port in plug
3.8		Non-return valve (Flap) angle, screw down	3.31		Cock, four-way, straight through in plug
3.9		Flap, straight through	3.32		Cock, with bottom connection
3.10		Flap, angle	3.33		Cock, straight through with bottom connection
3.11		Reducing valve	3.34		Cock, angle with bottom connection
3.12		Safety valve	3.35		Cock, three-way, with bottom connection
3.13		Angle safety valve	3.36		Solenoid valve
3.14		Self-closing valve	3.37		3-way test valve
3.15		Quick-opening valve	3.38		Thermostatic valve
3.16		Quick-closing valve	3.39		Valve with test flange
3.17		Regulating valve	3.40		3-way valve with remote control (Actuator)
3.18		Angle valve	3.41		Non-return valve (Air)
3.19		Ball valve (-Cock)	3.42		3/2 spring return valve, normally closed
3.20		Butterfly valve	3.43		2/2 spring return valve, normally closed
3.21		Gate valve	3.44		3/2 spring return valve, control by solenoid
3.22		Double-seated changeover valve	3.45		On/off valve controlled by solenoid and pilot directional valve and with spring return
3.23		Suction valve chest			















No.	Symbol	Symbol designation	No.	Symbol	Symbol designation
Control and regulating part					
4.1		Hand-operated	4.10		Electric motor driven
4.2		Remote control	4.11		Air motor driven
4.3		Spring	4.12		Manual (At pneumatic valve)
4.4		Mass	4.13		Push button
4.5		Float	4.14		Spring
4.6		Piston	4.15		Solenoid
4.7		Membrane	4.16		Solenoid and pilot directional valve
4.8		Electro-magnetic	4.17		By plunger or tracer
4.9		Flame trap			

Appliances







5.1		Mudbox	5.13		Heat exchanger
5.2		Simplex strainer	5.14		Electric pre-heater
5.3		Duplex strainer	5.15		Air filter
5.4		Magnetic filter	5.16		Air filter with manual control
5.5		Separator	5.17		Air filter with automatic drain
5.6		Steam trap	5.18		Water trap with manual control
5.7		Centrifugal pump	5.19		Air lubricator
5.8		Gear-or screw pump	5.20		Silencer
5.9		Hand pump (Bucket)	5.21		Fixed capacity pneumatic motor with spring returned
5.10		Ejector	5.22		Single acting cylinder with spring returned
5.11		Various accessories (Text to be added)	5.23		Double acting cylinder with spring returned
5.12		Piston pump	5.24		Auto drain trap

No.	Symbol	Symbol designation	No.	Symbol	Symbol designation
-----	--------	--------------------	-----	--------	--------------------

Fittings

6.1		Funnel	6.8		Air pipe with pressure-vacuum valve
6.2		Bell-mouthed pipe end	6.9		Deck fittings for sound's or filling pipe
6.3		Air pipe	6.10		Short sounding pipe with self-closing cock
6.4		Air pipe with net	6.11		Stop for sounding rod
6.5		Air pipe with cover	6.12		Oil tray coaming
6.6		Air pipe with cover and net	6.13		Bearing
6.7		Air pipe with pressure-vacuum valve	6.14		Water jacket

Reading instruments with ordinary symbol designations

7.1		Sight flow indicator	7.4		Distance level indicator
7.2		Observation glass	7.5		Counter (Indicate function)
7.3		Level indicator	7.6		Recorder

12 Appendix 2 (Instrumentation code)

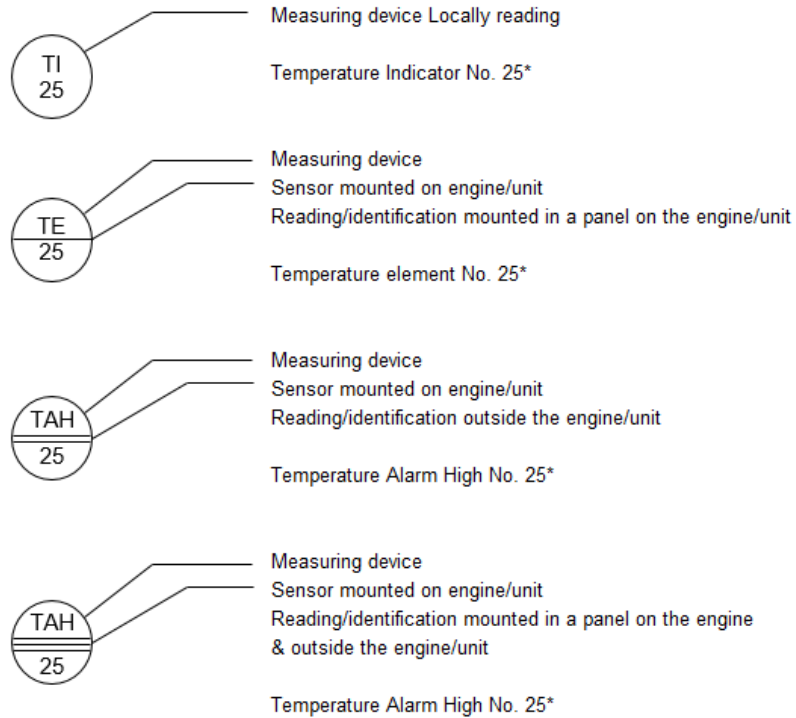

*Refer to standard location and text for instruments on the following page

Specification of letter code for measuring devices			
1st letter		Following letters	
F	Flow	A	Alarm
L	Level	D	Differential
P	Pressure	E	Element
S	Speed, Solenoid	H	High
T	Temperature	I	Indicating
U	Voltage	L	Low
V	Viscosity	S	Switching, Stop
Z	Position	T	Transmitting
		X	Failure
		V	Valve

Combustion gas system

- 21 Charge air at cooler outlet
- 25 Exhaust gas at cylinder outlet
- 26 Exhaust gas at turbocharger inlet
- 27 Exhaust gas at turbocharger outlet
- 49-1 Alternator winding 1
- 49-2 Alternator winding 2
- 49-3 Alternator winding 3

Compressed air system

- 40 Air starting valve / emergency stop valve
- 41 Compressed air at engine inlet
- 42 Turbocharger speed
- 43 Charge air condition valve
- 45 Stop solenoid on governor
- 46 Micro switch for turning gear
- 47 Engine speed
- 48 Over speed
- 49 On-off valve for shut down and over speed stop
- 50 Fuel rack limiter solenoid valve

Fuel oil system

- 51 Fuel oil at engine inlet
- 52 Fuel oil filter inlet
- 54 Leakage alarm tank

Lubricating oil system

- 61 Lubricating oil at filter inlet
- 62 Lubricating oil at engine inlet
- 63 Lubricating oil at turbocharger inlet
- 65 Pre-lubricating
- 68 Level in base frame
- 92 Oil mist detector

Cooling water system

- 71 Low temperature water at air cooler inlet
- 72 Low temperature water at air cooler outlet
- 75 High temperature water at engine inlet
- 76 High temperature water at engine outlet
- 77 High temperature water each cylinder outlet

Global Leader

www.hhi.co.kr

Copyright © 2020 Hyundai Heavy Industries Co., Ltd.
Contents subject to change without prior notice.
HiMSEN is trademark registered and owned
by Hyundai Heavy Industries Co., Ltd.

HYUNDAI
HiMSEN 