

BFHQTH15X24 - Watertight Hatch | Quick Acting | Oval 15" X 24" | Aluminum

These light-weight, quick-acting 4-dog models are ideal for high-traffic closures where speed and ease are paramount, and/or where positive engagement must be visually verifiable at a glance. The design is especially popular on aluminum boats, fishing and other workboats, as well as many U.S. Navy and U.S. and Canadian Coast Guard vessels.

FEATURES

- Adjustable Dog Tensioners that provide equal tension on all points, ensure a water-tight seal
- Built-in "Never Lose" handle
- A simple 1/8th-turn of the handle provides smooth, easy and secure engagement
- Thicker Dog Arms for superior strength
- Positive visual verification: When the handle is down, the hatch is secured
- Inside escape bar on all units (optional inside turning wheel available)
- Subtle design improvements make the BFHQ stronger, more water-tight than our competitors' similar units
- Cast from high-grade corrosion-resistant 356 aluminum alloy (ASTM B26)
- Maximum durability, stronger deck strength and impact resistance
- Stainless steel T-handle and operating hardware
- Dissimilar metals isolated by neoprene and nylon

WATER-TIGHT:

- Machined surfaces and superior casting processes control tolerances
- Neoprene cover gasket and sealing ring ensure tight seal



MATERIALS

Currently, the 4-dog BFHQ series hatch cover assemblies are available only in cast aluminum. However, the deck rings for the BFHQ are the same size as the Strongback models, and are available in galvanized mild steel or cast aluminum. Stainless Steel deck rings are available by special order.



This hatch is ABS Certified for use on ABS classed vessels or facilities by the American Bureau of shipping.

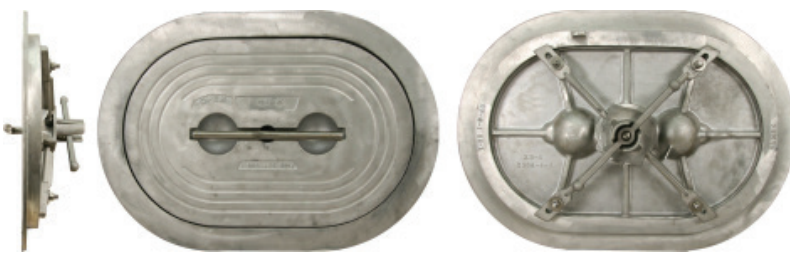

BFHQTH15X24A/A with Cast Aluminum Deck Ring

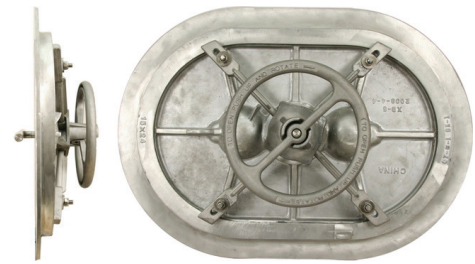

BFHQTH15X24A/A with Optional Handwheel

When ordering please specify:

Cover Material:
cast aluminum
only

Ring Material:
cast aluminum,
galvanized steel,
or stainless steel.

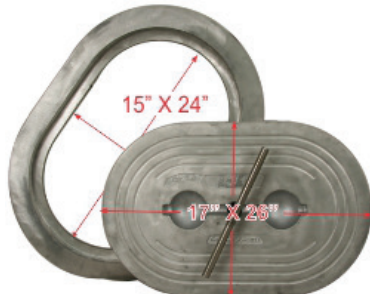

Hatch Covers Available Separately

Model Number	Cutout Dimension in. (mm)	Hatch Material	Autocad PDF/DXF
BFHQTH15X24A/A		Aluminum / Aluminum	BFHQTH15X24A-A DXF (ZIP)
BFHQTH15X24A/S		Aluminum / Steel	
BFHQTH15X24A/SS		Aluminum / Stainless Steel	

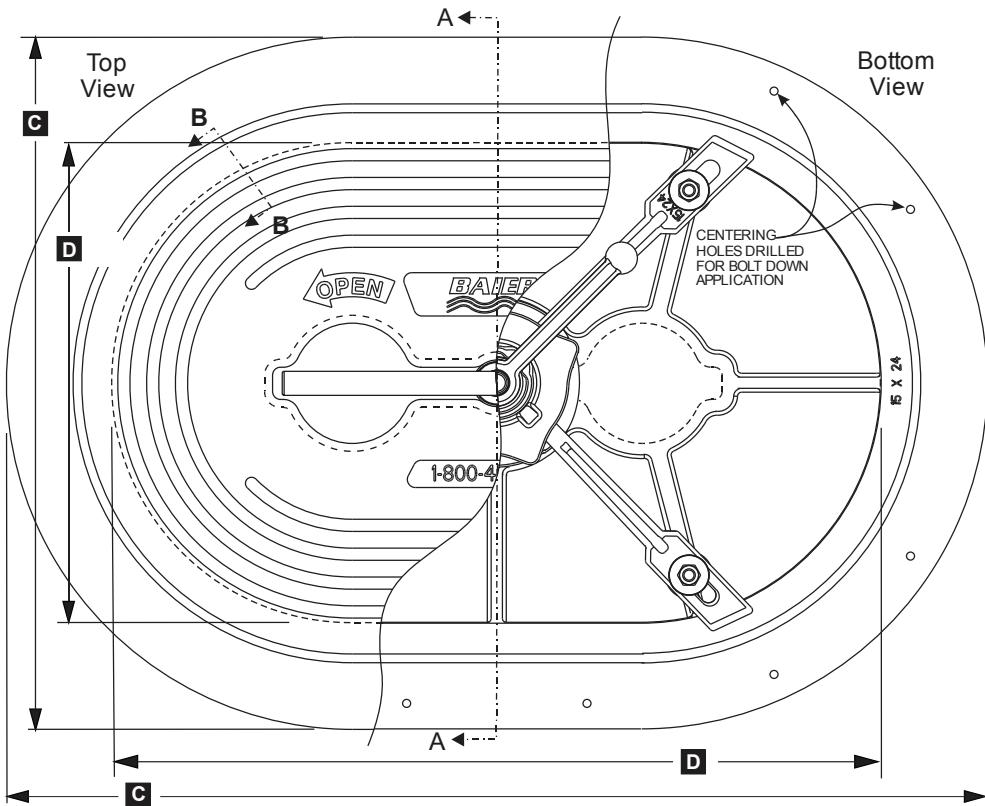

BILL OF MATERIAL: 08864-101

#	DESCRIPTION	MAT	P/N
1	COVER	AL	08864-201A
2	DOG HUB ASSY	AL	08864-102A
3	(4) DOG ARM	AL	08864-203A
4	GASKET	NEO	08864-701A
5	BUSHING	SS	08864-804A
6	O-RING	NEO	08864-702A
7	T-HANDLE	SS	08864-401A
8	DECK RING AL	AL	08861-203A
8	DECK RING ST	ST	08861-207A
9	ESCAPE HANDLE	AL	08864-213A
10	HANDLE PIN	SS	08864-801A
11	(4) THREADED POST	SS	08864-802A
12	(4) WASHER	SS	08864-805A
13	(4) WASHER	UP	08864-803A
14	(4) NYLOCK NUT M10	SS	08864-807A

MATERIAL KEY

AL	- ALUMINUM
ST	- GALV. STEEL
SS	- STAINLESS STEEL
UP	- UHMW POLY
NEO	- NEOPRENE

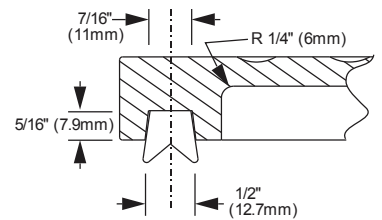

GASKET GROOVE, SECTION B:B

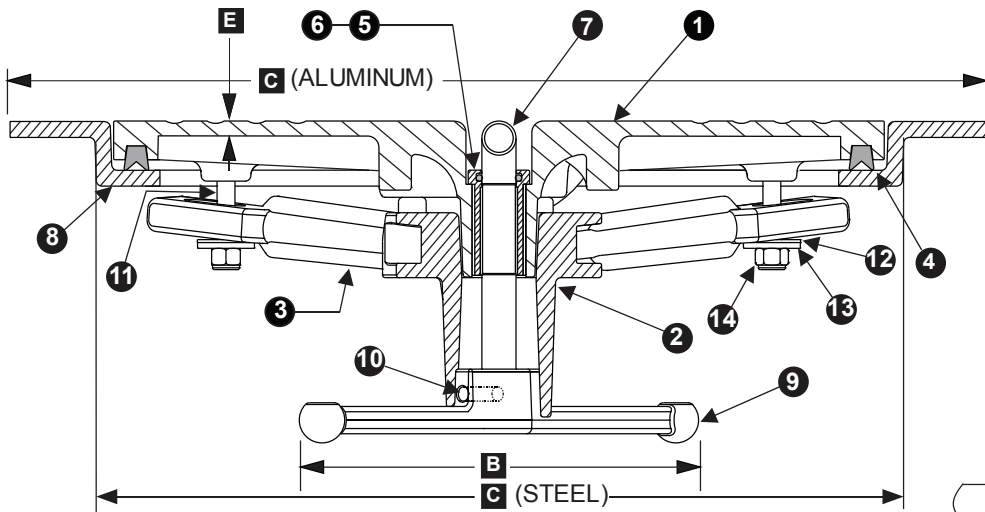

SECTION A:A

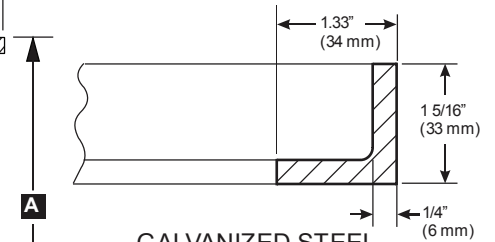

GALVANIZED STEEL DECK RING

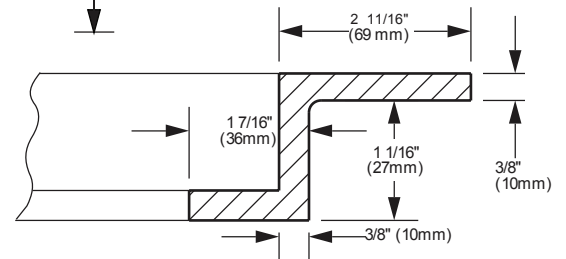

CAST ALUMINUM DECK RING

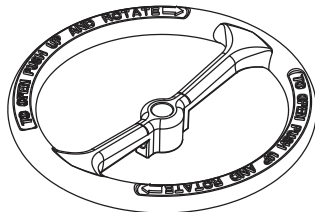

OPTIONAL ESCAPE HANDWHEEL (REPLACES ESCAPE HANDLE)

IMPORTANT: WHEN ORDERING, PLEASE SPECIFY OUTSIDE DIAMETER (C) OR CLEAR OPENING (D). UNITS ARE IDENTIFIED BY CLEAR OPENING.

HATCH WEIGHTS LBS. (KGMS)*

Model Number	BFHQTH15X24
Material	AL ST
Cover	25.8 (11.7) N/A
Deck Ring	9 (4.1) 12 (5.4)

DIMENSIONS INCHES (mm)

Model Number	A	B	C (AL)	C (ST)	D	E
BFHQTH15X24	7 1/16 (179)	12 (305)	30 7/16 x 21 7/16 (777 x 548)	26 1/2 x 17 1/2 (673 x 445)	24 x 15 (610 x 381)	1/4 (6)
BFHQTHF15X24 Cover Assembly Only	7 1/16 (179)	12 (305)	N/A	N/A	N/A	1/4 (6)

(Cover Dimension 25.75" x 16.88") Cover Only - Replacement for similar competitive models

BAIER Marine Company, Inc.
 1-800-455-3917
 206-632-2441 (FAX)
 sales@baiermarine.com

BAIER FLUSH HATCH
 LIFT-OUT MULTI-DOGGED TYPE
 WITH BUILT-IN T-HANDLE
 TYPE "D" QUICK ACTING
 POSITIVE LOCK
MODEL BFHQTH15X24

DWG. 08864-101