

### **BFHHQTH15X24 - Internal Hinge Watertight Hatch | Quick Acting | Oval 15" X 24" |**

#### **Aluminum**

These light-weight, quick-acting 4-dog models are ideal for high-traffic closures where speed and ease are paramount, and/or where positive engagement must be visually verifiable at a glance. The new Baier Hidden-Hinge, fully-articulated commercial marine flush deck hatch assembly for workboats adds the convenience of a built-in recessed Stainless Steel T-handle to the flush-mounted, quick release, lift-out hatch. The design is especially useful for aluminum boats, crew supply vessels (CSV), fishing vessels and other workboats, as well as many U.S. Navy and U.S. and Canadian Coast Guard vessels. This new hinge assembly works exceeding well when installed vertically like a door -- it pivots easily and maintains alignment. An over-center auto stop holds cover securely open at 120 degrees, and the hatch cover slides further open to over 180 degrees.

#### **FEATURES**

- Opens to 180 degrees-plus
- Over-center auto stop holds cover securely open at 120 degrees
- Auto-stop releases quickly with a push-lever
- Stainless hardware, Delrin slides
- Works equally well in flush deck or vertical mount positions – perfect for a lazarette hatch-door
- Thicker Dog Arms for superior strength
- Positive visual verification: When the handle is down, the hatch is secured
- Inside escape bar on all units (optional inside turning wheel available)
- Subtle design improvements make the BFHQ stronger, more watertight than our competitors' similar units

#### **Shared With Classic HEX-Bolt Series:**

- Available in 20" Round, 15" X 24" Oval or 24" x 24" Square
- Available with aluminum or galvanized steel deck ring

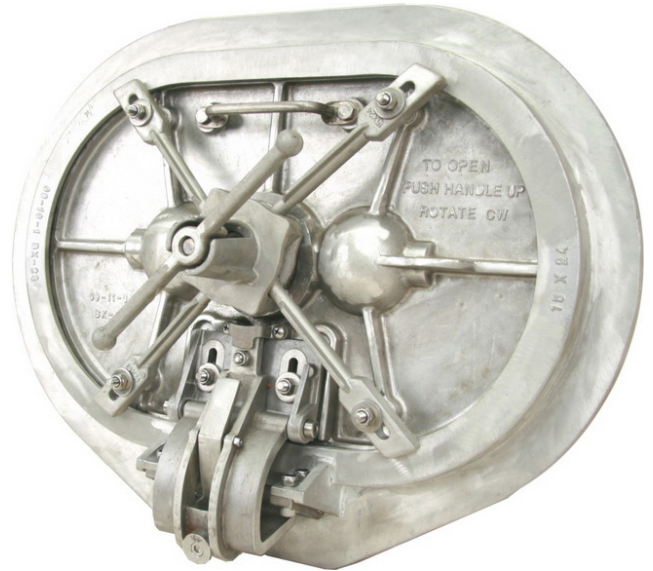

#### **MATERIALS**

Currently, the 4-dog BFHQ series hatch cover assemblies are available only in cast aluminum. Deck rings are available in galvanized mild steel or cast aluminum. Stainless Steel deck rings are available by special order.



This hatch is ABS Certified for use on ABS classed vessels or facilities by the American Bureau of shipping.



BFHHQTH15X24A/A with Cast Aluminum Deck Ring

BFHHQTH15X24A/A with Internal Hinge

When ordering please specify:

Cover Material: cast aluminum only

Ring Material: cast aluminum, or galvanized steel (See PDF download for steel ring design)



Hatch Covers Available Separately

Model Number	Material - Hatch / Deck Ring	Autocad PDF/DXF/XML
BFHHQTH15X24A/A	Aluminum / Aluminum	<a href="#">BFHHQTH15X24A-A DXF (ZIP)</a>
BFHHQTH15X24A/S	Aluminum / Steel	BFHHQTH15X24A-S

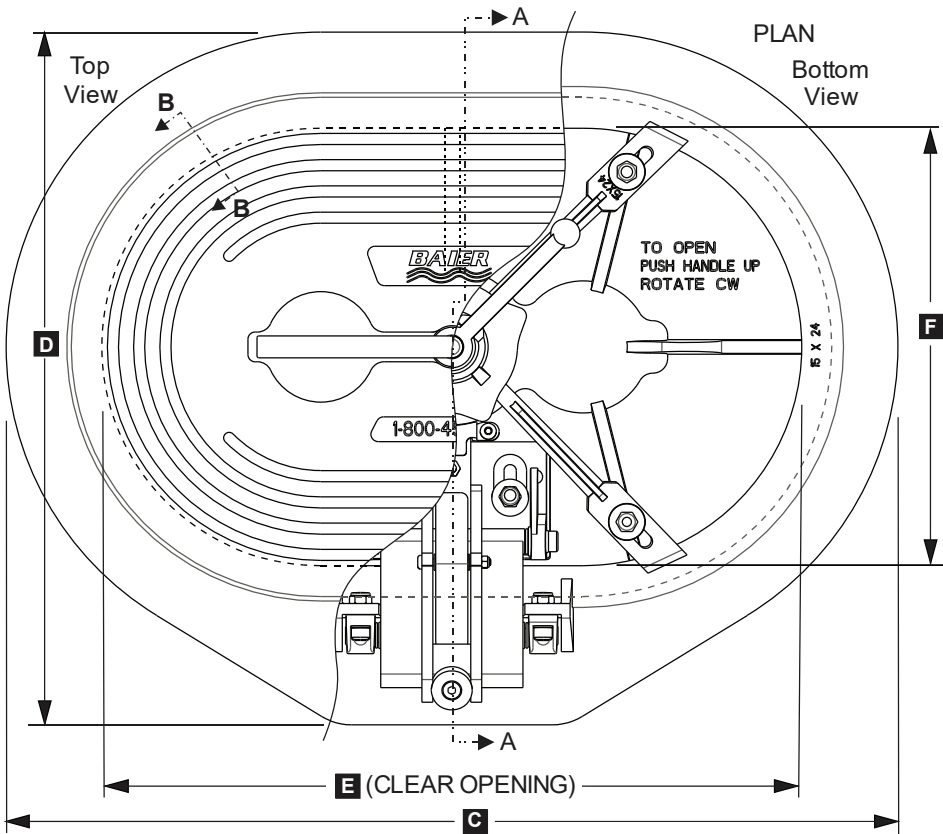

**BILL OF MATERIAL: 08863-115**

#	DESCRIPTION	MAT	P/N
1	COVER	AL	08863-255A
2	DOG HUB ASSY	AL	08864-102A
3	(4) DOG ARM	AL	08864-203A
4	GASKET	BUNA	08864-701A
5	BUSHING	SS	08864-804A
6	O-RING	BUNA	08864-702A
7	T-HANDLE	SS	08864-401A
8	DECK RING	AL,ST	08863-257A,B
9	ESCAPE HANDLE	AL	08864-213A
10	HANDLE PIN	SS	08864-801A
11	(4) NYLOCK NUT	SS	08864-807A
12	(4) WASHER	SS	08864-805A
13	(4) WASHER	UP	08864-803A
14	(4) THREADED POST	SS	08864-802A
15	GRAB HANDLE	SS	08863-405A
16	(4) ARM SPRING	SS	08864-809A
17	HINGE ASSY	DETAIL	08864-126B

**MATERIAL KEY**

AL	- ALUMINUM
ST	- GALV. STEEL
SS	- STAINLESS STEEL
UP	- UHMW POLY
BUNA	- NITRILE RUBBER

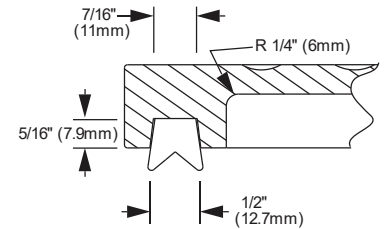

GASKET GROOVE, SECTION B:B

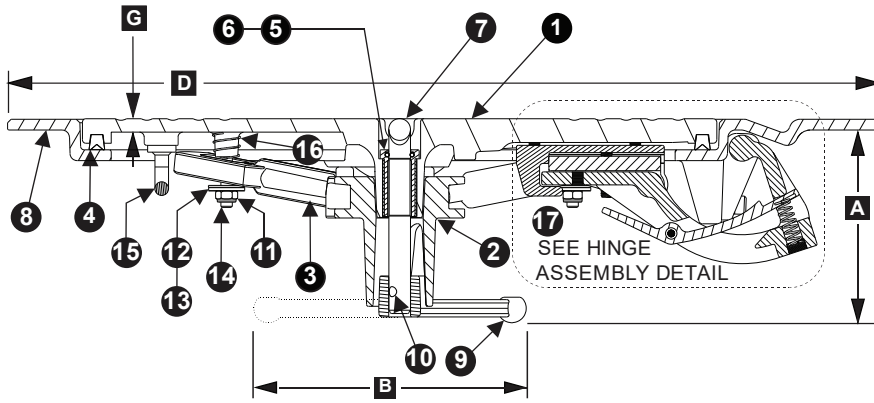

SECTION A:A

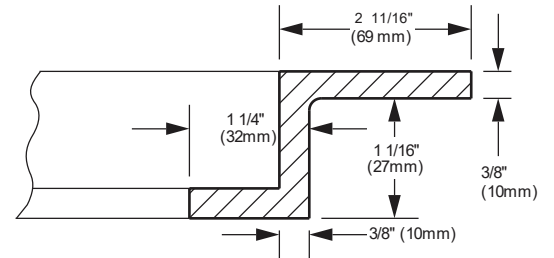

CAST ALUMINUM & GALVANIZED STEEL DECK RING

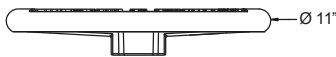

OPTIONAL: ESCAPE HANDWHEEL (REPLACES ESCAPE HANDLE)

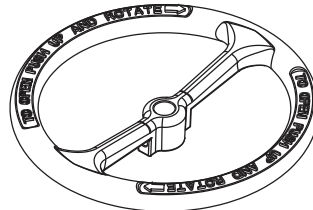

HATCH WEIGHTS LBS. (KGS)	
Model Number	BFHHQTH15X24
Material	AL ST
Cover	26.5 (12) N/A
Deck Ring	13.5 (6) 33 (15)
Hinge & Hardware	SS 8 (.36)

IMPORTANT: WHEN ORDERING, PLEASE SPECIFY OUTSIDE DIAMETER (C) OR CLEAR OPENING (E). UNITS ARE IDENTIFIED BY CLEAR OPENING.

Model Number	DIMENSIONS INCHES (mm)						
	A	B	C (AL&ST)	D (AL&ST)	E	F	G
BFHHQTH15X24	6 1/2 (165)	12 (305)	30.6 (777)	23 3/4 (603)	24 (508)	15 (381)	5/16 (8)

**BAIER** Marine Company, Inc.  
 1-800-455-3917  
 206-632-2441 (FAX)  
 sales@baiermarine.com

**BAIER FLUSH HATCH**  
 INTERNAL HINGED MULTI-DOG  
 WITH BUILT-IN T-HANDLE  
 TYPE "D" QUICK ACTING  
 POSITIVE LOCK  
**MODEL BFHHQTH15X24**

DWG. 08863-115